

Supporting Basic Plant Science

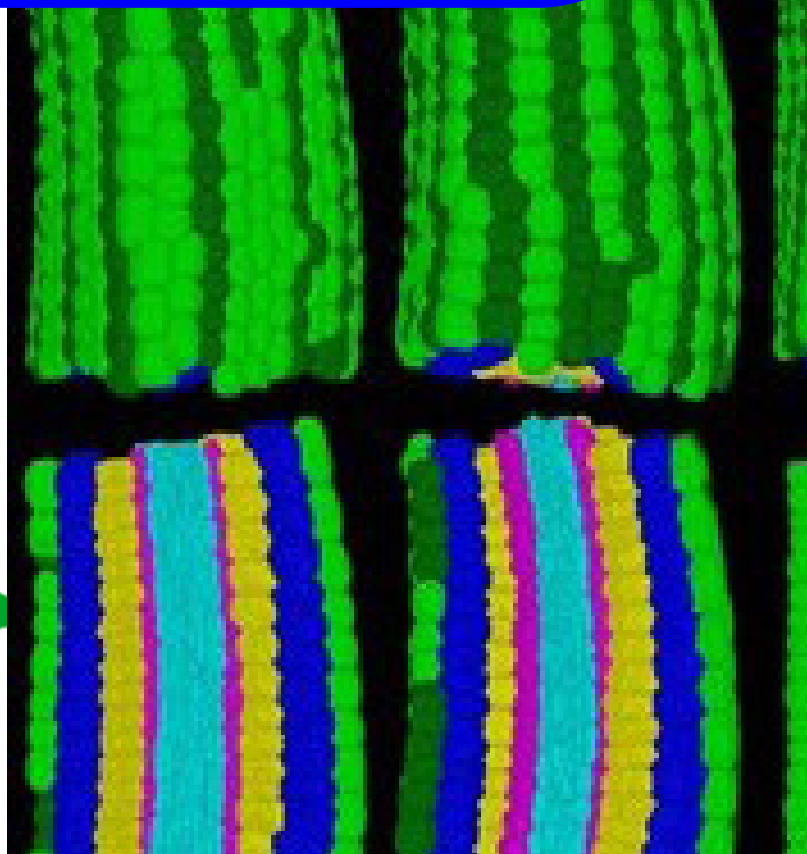

 Welcome to the June 2018 Issue of GARNish



Steven Spoel

GARNet Chairman

Welcome to this new issue of GARNish with plenty of news, views and reports from the UK plant sciences community. GARNet's main priority is to support the fundamental and wider plant sciences communities in the UK. In the past 6 months we have done just that as illustrated by several articles in this issue. In response to community concerns over reduced availability of funding for fundamental plant science, GARNet set out to investigate if these concerns are fact or fiction. Uncovering research funding patterns is a complex task that requires intimate knowledge of how the plant science community approaches grant funding and how funders assess grant applications.

Therefore GARNet teamed up with the BBSRC, the predominant funder of fundamental, translational and applied plant science, and performed an in depth analyses of plant science funding. In this issue of GARNish we report back to the community our full analyses and findings, which uncovered some surprising trends. In brief we found that indeed there has a decline in the number of funded fundamental plant science grants, but that the reasons for this decline are more complex than anticipated. For example, we also found that the number of submitted grants involving fundamental plant science has declined at a faster rate than the reduction in funded grants of this type. Moreover, we identified a simultaneous decrease in plant science grant applications of any type (i.e. fundamental, translational or applied). As the size of the fundamental and overall plant science communities in the UK has not significantly changed in recent years, these are worrying trends that we feel should be addressed immediately. Therefore we make several recommendations to the community and to the BBSRC that we hope will help reverse this trend sooner rather than later. Whether you are a Principal Investigator, early-career researcher, PhD student or otherwise

Contents

Editorial	2
The GARNet Committee	3
UKPSF and GPC Update	4
News	6
Support for Basic Research	8
BBSRC IMPACT	16
Funding News	18
Introducing Araboxcis	20
Rethinking Epitope tags	22
Monogram2018	26
Earlham BioFoundry	28
Spotlight on RHUL	30
GARNet Gene Editing Workshop	40

Special thanks to: Jon Carruthers, Sarah Jose, Rocio Gaudioso-Pedraza, Steve Penfield, Piers Hemsley, Tony Pridmore, Jose Carrasco-Lopez, Daphe Ezer, Toby Barber, Patrycja Sokolowska, Ashley Pridgeon, Beth Eldridge, Enrique Lopez-Juez and the plant scientists at RHUL.

> Cover images: Top L: <https://elifesciences.org/articles/31804>
Top R: <https://elifesciences.org/articles/18165> Bottom L: <http://arabidopsis.info/> Bottom R: <https://elifesciences.org/articles/26023>

involved in UK plant science, I urge you to take a look at our analyses and recommendations. Change often comes from within and plant science research funding is no exception.

Our work with the BBSRC also revealed that the plant science community and the BBSRC do not always speak the same language. For example, the meaning of research "Impact" often differs between our daily usage in universities and institutes on the one hand, and how this term is defined by funding agencies. Therefore we invited the BBSRC Strategy and Policy Officer for Frontier Biosciences, Rocio Gaudioso-Pedraza, to contribute an article in this issue of GARNish

The GARNet Committee

Steven Spoel

University of Edinburgh
GARNet Chair.
Committee member Jan 2016–Dec 2018

Jim Murray

University of Cardiff
GARNet PI from February 2015

Ruth Bastow

Global Plant Council
Ex-officio member

Daniel Gibbs

University of Birmingham
Committee member Jan 2017–Dec 2019

Murray Grant

University of Warwick
Committee member Jan 2017–Dec 2019

Jill Harrison

University of Bristol
Committee member Jan 2017–Dec 2019

Andrea Harper

University of York
Committee member Jan 2018–Dec 2020

Saskia Hogenhout

John Innes Centre
Committee member Jan 2016–Dec 2018

Sabina Leonelli

University of Exeter
Ex-officio member

Sean May

Nottingham Arabidopsis Stock Centre
Ex-officio member

Sarah McKim

James Hutton Institute, University of Dundee
Committee member Jan 2018–Dec 2020

Christine Raines

University of Essex
Committee member Jan 2016–Dec 2018

Colin Turnbull

Imperial College
Committee member Jan 2018–Dec 2020

Geraint Parry

Cardiff University
GARNet Coordinator

to explain how BBSRC interprets "Impact". I encourage you to take note of this, as it clearly illustrates there is plenty of room for all types of plant science to make an impact, including fundamental research in model plants.

As I am entering the final 6 months of my GARNet chairmanship, I realise that much work remains to be done. But we should also celebrate what GARNet has accomplished in delivering training to the community, in creating ties with other organisations and societies, in working closely with our funders, and in representing the plant science community in numerous government

consultations. While GARNet looks to what the future may bring for UK plant sciences, we hope you will keep engaging with us. A great way for you to stay up to date with the advances of the community is by looking at our blog (<http://blog.garnetcommunity.org.uk/>), our YouTube channel GARNet Community, and of course this issue of GARNish, which is once again packed with exciting news and views from around the UK.

Views expressed by authors in GARNish are their own opinions and do not necessarily represent the view of GARNet or the BBSRC.

 UK Plant Sciences
Federation Update



Jonathan Carruthers
Royal Society of Biology

jonathan.carruthers@rsb.org.uk

Following the successful launch of the Plant Health Undergraduate Studentships scheme in 2017, the UKPSF offered an expanded scheme this year with more placements available, thanks to support from Defra, BSPP and N8 Agrifood. The programme aims to address skills shortages in plant health research and provide training opportunities for students by providing paid research projects that address major plant health challenges identified by Defra. Nine projects were funded following an open call for proposals, and these opportunities were advertised to undergraduates, garnering 181 applications. Students will undertake their research projects for 8-10 weeks over summer on topics as diverse as characterising novel viruses found on crops v brought on eBay, developing tools for early detection of diseases in strawberry plants, and understanding the response of aphids to plant signals of insect herbivory.

The UKPSF is creating a short report for policymakers that aims to demonstrate the value and potential of UK plant science. Review by the community will be integral to the final report which has a working title UK Plant Science: Growing the Future. The draft will be available to review for a two-week period only from 26 June 2018.



The launch of the report will be marked with a one-day meeting later in 2018, focused on challenges and opportunities in plant science and the perspectives of the different actors in the innovation process. Further information about the meeting will be available shortly.

The UKPSF also produces a monthly round-up of plant science policy headlines and stories. To sign up for this newsletter, visit the Royal Society of Biology's MySociety portal and choose from the options on the 'My Subscriptions' page, via the 'Me and the RSB' tab.

 Global Plant
Council Update

Sarah Jose

GPC Outreach and
Communications Manager
sarah@globalplantcouncil.org



We're pleased to announce that the GPC will be holding a workshop at the Annual Meeting of the American Society of Agronomy and the Crop Science Society of America, which will take place in Baltimore, Maryland, USA, in November. The one-day workshop, which costs just \$20 to attend, is entitled "Enhancing Global Collaborations in Crop Science", and will bring together researchers from around the world to discuss how best to facilitate international collaboration between researchers and policy experts in crop science. We hope to develop new ideas and models for large-scale cooperation and integration to focus and enhance research efforts.

The workshop will take place on Sunday 4th November before the main ASA CSSA meeting, which runs from the evening of Sunday 4th November and until 7th November. We'd love to see you there!

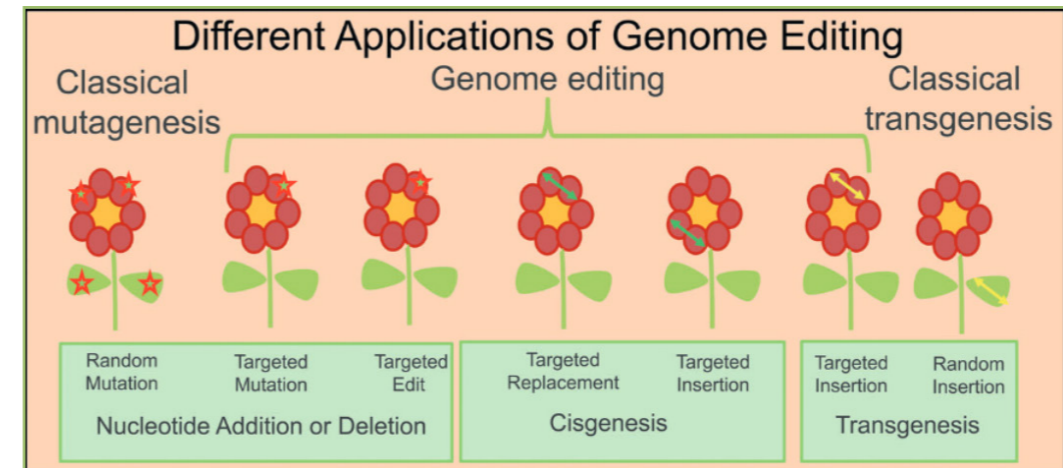

Types of genome manipulation used in plant breeding and cultivar development. Image modified from that kindly supplied by Petra Jorasch, European Seed Association (www.euroseeds.eu).

For more information about the workshop and how to register, please check out the ASA CSSA webpage: <https://www.acsmeetings.org/workshops>

Speaking of workshops, last year the GPC teamed up with the Society for Experimental Biology and GARNet to hold the very successful New Breeding Technologies workshop in Gothenburg, Sweden. Attendees discussed a range of issues, sharing tips on the best new gene editing techniques as well as learning more about the regulatory issues surrounding the use of these technologies around the world.

As an output of this meeting, a series of papers have begun to be published in *Physiologia Plantarum*. At the time of writing, two papers are available online:

"Scandinavian perspectives on plant gene technology: applications, policies and progress" by Dennis Eriksson, Henrik Brinch-Pedersen, Aakash Chawade, Inger B. Holme, Trine A.K. Hvoslef-Eide, Anneli Ritala, Teemu H. Teeri, and Tage Thorstensen. doi: [10.1111/ppl.12661](https://doi.org/10.1111/ppl.12661)

- "Meeting report: Separate product from process: framing the debate that surrounds the potential uptake of new breeding technologies" by GARNet's own Geraint Parry and myself. doi:[10.1111/ppl.12680](https://doi.org/10.1111/ppl.12680)

You can find these papers on our New Breeding Technologies initiative page (<http://globalplantcouncil.org/initiatives/new-breeding-technologies>), which also features many other resources including presentations from the meeting and the GPC's consensus statement on New Breeding Technologies. The consensus statement contains recommendations for governments regarding the regulation of the use of these techniques and the products generated using them. Please do feel free to share these resources with anyone who might find them useful!

Following our 2017 Annual General Meeting, the GPC has begun to establish a series of Working Groups, which will help us to drive our initiatives forward. Sign up to our monthly newsletter (<http://tinyurl.com/GPCbulletin>) for more information about their progress in the coming months.

Don't forget, you can always keep up to date with the latest from GPC, as well as plant science events and news from around the world, by joining our 5300 followers on Twitter (@GlobalPlantGPC) or the 1000+ followers of our Spanish language account (@GPC_EnEspanol). You could also sign up to our monthly e-Bulletin newsletter (<http://tinyurl.com/GPCbulletin>) or visit our website (www.globalplantcouncil.org) for more daily updates!

GARNet2018: a Plant Science Showcase:

September 17th-18th 2018,
University of York

The biennial GARNet2018 will take place on September 18th and 19th 2018 in the Ron Cooke Conference centre at the University of York. We again focus on new technologies are being used by researchers across all areas of plant science.

GARNet2018 includes talks from researchers who work in both model organisms and crop plants, each of the talks linked by outstanding science.

Some of the many highlights include:

- > Five Plenary Sessions
 - > Large Scale Biology
 - > Innovations in Hormone Signaling
 - > Interacting with the Environment
 - > Out of Arabidopsis
 - > Novel Cell Imaging
- > Keynote talk provided by Professor Dame Ottoline Leyser
- > Ten talks selected from submitted abstracts
- > Fifteen Flash presentations
- > Workshop on '*Taking the scary route: Scientific careers away from the well worn path*'
- > Lunchtime discussion session on techniques for Data Management led Professor Andrew Millar

All the information can be found here:
<https://garnet2018.weebly.com/>

GARNet2018: a plant science showcase University of York September 18-19th 2018

GARNet CyVerseUK workshop on RNAseq

December 12th-13th 2018
Earlham Institute, Norwich

GARNet are following up from our successful CyVerseUK workshop hosted by the University of York in March 2017 with an hands-on workshop that is focussed on analysis of RNAseq data.

The workshop is designed for biologists who have limited bioinformatic skills and are analysing RNAseq datasets that they have generated as part of their wet-lab research.

This workshop is led by Jason Williams who is the Assistant Director of the CSHL DNA Learning center alongside faculty and staff from the Earlham Institute in addition to external contributors from members of Cristobal Uauy's lab at the John Innes Centre.

The meeting is receiving financial and supervisory support from the BBSRC funded Collaborative Open Plant 'Omics grant (COPO)
www.copo-project.org



Day 1: Tuesday December 11th

Meeting Start: 9am

- Hands-on Introduction to CyVerse and CyVerseUK
- Adding data to the CyVerse repository.
- Introduction to methodologies available for analysis of global RNA samples.
- Introducing the components of the Tuxedo RNAseq analysis pipeline
- Explaining the biological relevance of RNAseq analysis outputs
- Set up Tuxedo pipeline with supplied RNAseq files

v

- Open Data
 - What is Open Data?
 - Planning your research to deal with big data
 - Introducing COPO
- How reusing data can benefit your research
 - Strategies for data reuse
 - Examples of successful data reuse
- Hands-on session with analysis of supplied dataset (continued from D1)
- Visualisation of outputs from Tuxedo pipeline
- Exploring the options for visualising your RNAseq data
- Examples of visualising RNAseq data
- Introducing Earlham Institute web resources

Meeting End: 4pm

Please look out for registration details for this workshop appearing over the summer.

Day 2: Wednesday December 12th

Reversing the Decline in Plant Science Applications to the BBSRC Responsive Mode:

Analysis and recommendations from GARNet

GARNet Advisory Committee

geraint@garnetcommunity.org.uk

GARNet is a community-facing UK network funded by BBSRC through Responsive Mode that supports the delivery of outstanding plant science research. GARNet's primary focus is supporting researchers who work on fundamental areas of plant science, particularly around the adoption of new technologies and new ways of working. Recently members of the plant science community have expressed concerns about a perceived lack of opportunities to obtain funding for fundamental plant science.

The primary mechanism for obtaining funding of this type comes through BBSRC Responsive Mode funding predominantly via Research Committee B: Plants, microbes, food and sustainability. As a service to the community, GARNet asked the BBSRC to analyse their data regarding the number of plant science applications, which is not in the public domain. The BBSRC found that the number of total plant science applications is declining in line with the number of funded projects. However the number of applications to study aspects of fundamental plant science is declining at a faster rate (Figure 1). Our findings allowed us to make a series of recommendations that are outlined at the end of this article.

- In recent years funding for fundamental plant science research has declined

Since 2014 the success rate for grants submitted to Research Committee B has remained between 20-25%. However we found that across all successful grants the distribution of research topics has changed. We illustrated these changes in two ways. Firstly we divided the successful grants into four categories: Category 1- grants that use Arabidopsis in any part of the proposed work, Category 2- grants that propose to work with cereals, Category 3- grants that propose to work with any other plant species, such as potato or tomato, Category 4- grants that do not include any aspect of plant science (Figure 1A).

Secondly we interrogated the text descriptions of successful plant science grants and characterised them as being 'fundamental' or 'translational/applied' (Figure 1B). This analysis includes an important caveat that the classifications have been determined from written descriptions so the actual research program might include fundamental or translational/applied activities that are not immediately obvious and that sometimes the distinction between these categories is blurred.

Figure 1A shows that the split between plant and non-plant grants had remained consistent between 2014-2016 although over the past year support for non-plant grants has risen. Within the plant categories (1-3), the number of grants in category 1 has declined whereas category 3 grants have increased. Categories 2 and 3 grants predominantly, although not exclusively, included translational/ applied research, which explains why category 1 in Figure 1A is similar to the 'fundamental' portion of Figure 1B. Figure 1

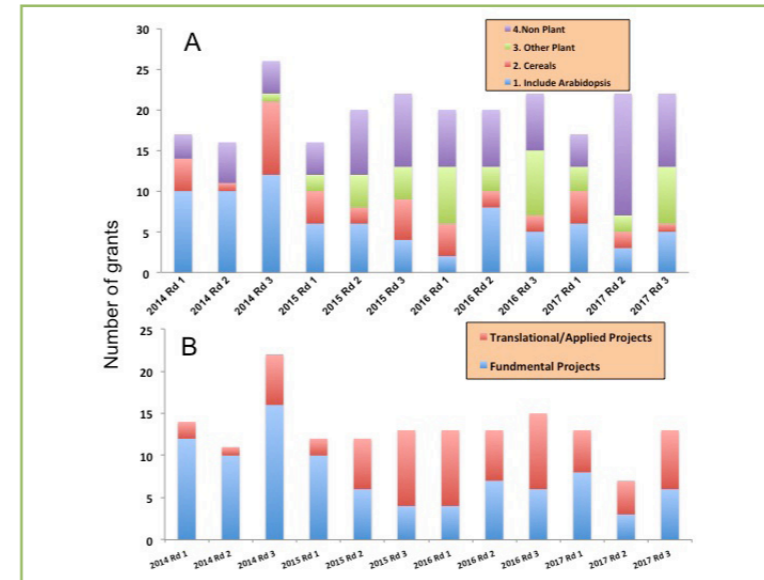

Figure 1: BBSRC responsive mode grants funded by Research Committee B between 2014-2017. A- Successful grants have been placed in four categories: 1. Grants featuring any Arabidopsis research 2. Grant focused on Cereals 3. Grants focused on research using another plant 4. Grants that focus on non-plants B- Successful plant science grants have been divided into those that propose to work on fundamental vs translational/applied areas of research. In this analysis multiple awards >£100K to work on the same great are treated as separate awards.

appears to support the perceived concerns within GARNet of a decline in support for fundamental plant science.

This decline should be of wider concern given that research in Arabidopsis and other model organisms underpins much of the work that is now supported in wheat and other cereals and drives the world-class basic research for which the UK plant science community is recognised. Without this fundamental work incentivizing new techniques and discoveries, it is highly likely translatable opportunities will diminish and result in reduced international competitiveness. Because Responsive Mode is the primary support route for fundamental research, which is typically underrepresented in strategic priority calls (e.g. GCRF, ISCF), we approached BBSRC to inquire whether there has been a change in policy

regarding the support for fundamental research grants. BBSRC responded clearly that the answer is no.

- BBSRC data highlight a worrying decline in plant science submissions

Information about the total applications made to Responsive Mode is in the public domain and the numbers submitted to Committee B have remained constant over the past 4 years. However information about the distribution of research topics within those unfunded submissions is not publically available. Upon GARNet's request the BBSRC examined their in-house information regarding plant science grants submitted to responsive mode, the categorisation of which were determined with the same caveats as above. Figure 2 shows that the number of successful grants has declined, both for plant sciences as a whole (Figure 2A) and for those that are characterised as fundamental research (Figure 2B). This information matches GARNet's findings from Figure 1.

The underlying driver of the trends in Figure 2 is the drop in total number of plant science applications over that time-period, which is proportional to the decline in funded grants (Figure 2A). However the number of grants submitted that propose to work on fundamental plant science has declined at a faster rate than the decline in funded grants of this type (Figure 2B).

A BBSRC member of staff familiar with the plant science funding landscape attended the GARNet advisory committee meeting in December 2017 to discuss these findings. The minutes from the meeting can be downloaded from the GARNet website and the topics discussed are documented below.

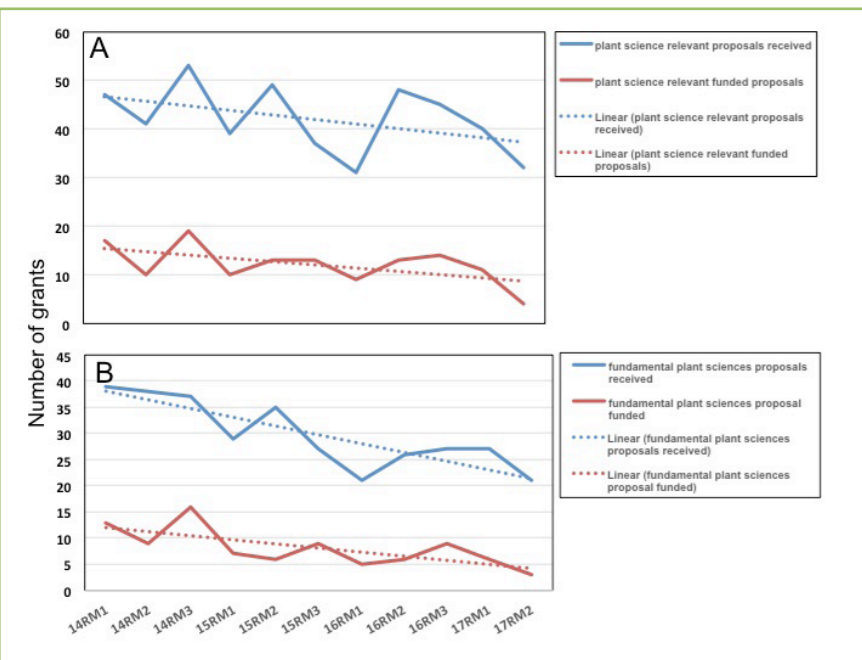

Figure 2: Decline in plant science application to BBSRC Responsive Mode A- showing number of submitted and successful grants from Responsive Mode that propose to work on any aspect of plant science (2014-2017)

B- showing number of submitted and successful grants from Responsive Mode that propose to work on an aspect of fundamental plant science (2014-2017). Data provided by BBSRC.

What are the reasons that explain the decline in submitted plant science applications and especially those that propose to work on fundamental topics?

- Are there less UK plant scientists engaging in fundamental research?

There is no available data that directly documents whether there is less research activity in either plant science in general or specifically in fundamental areas of plant science. In an attempt to assess whether the number of researchers working on fundamental plant science has changed over the past few years we investigated two proxy measures.

Activity: Figure 3 shows that the seed stock orders from the Nottingham Arabidopsis Stock Centre (NASC) by UK institutions has largely remained steady over the past four years. Given that stock orders most likely represents the initiation of a new research project this data suggests that in the UK the amount of Arabidopsis research is increasing or at the very least continuing at a similar level.

Outputs: When the NCBI PubMed database is searched for "Arabidopsis" and "UK" it shows that the number of original research papers has risen since 2014 (Figure 4). GARNet categorically recognises that 'fundamental' research does not exclusively represent that conducted using Arabidopsis but feel it is a reasonable comparison for our purposes.

Therefore Figures 3 and 4 indicate that fundamental plant science research activities using Arabidopsis have not decreased in recent years across the UK. This mirrors the global situation that continue to see a rise in the number of publications in which Arabidopsis is the primary research organism, demonstrating that other countries retain an emphasis in fundamental plant science research.

- Are UK Plant Scientists applying for funding elsewhere?

Agriculture and Food Security is a BBSRC strategic research priority and the past years have seen more funding opportunities for researchers who work in translational or applied aspects of plant science. The recent implementation of the Global Challenges Research Fund (GCRF)

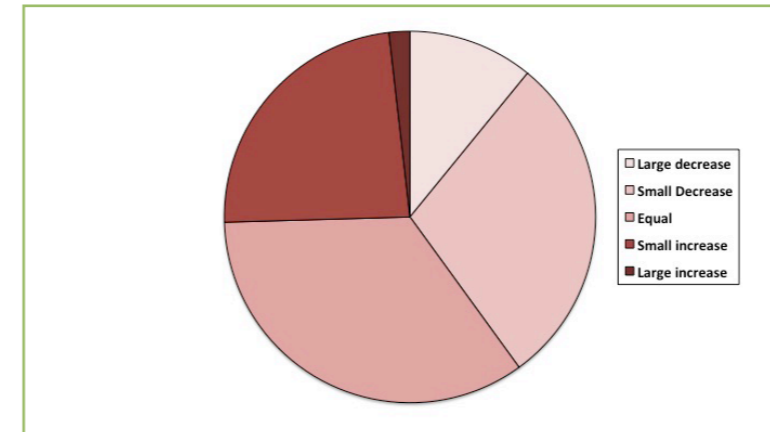

Figure 3: Change in number of Arabidopsis seed stocks ordered from NASC between 2014 and 2017. Between 2014-2017 each UK academic institution was ranked by the number of Arabidopsis seed stocks they ordered from the Nottingham Arabidopsis Stock Centre (NASC). Rank 1= No orders; rank 2= 1-99 orders; rank 3= 100-999 orders; rank 4= 1000+ orders. For each institution the 2017 rank number was subtracted from the 2014 rank number to give a final value that is included in this figure. For this figure a value of -2= large decrease in seed stock orders, -1= small decrease in seed stock orders 0= no change in seed stock orders 1= small increase in seed stock orders 2= large increase in seed stock orders. For example The University of York ordered 1000 seed stocks in 2014 (rank 4) and between 100-999 in 2017 (rank 3) and therefore receives a value of -1 (small decrease). Data kindly provided by NASC.

has provided unprecedented opportunities for translational and applied plant scientists who are working on topics relevant to ODA countries and to a lesser extent, translational opportunities to exploit outputs from fundamental plant science. This spread of opportunities appropriate for more translational/applied plant scientists might therefore reduce the total number of plant science applications made to Research Committee B.

Since 2013 the BBSRC has provided over £12M supporting 27 grants funded through the ERA-CAPS program. Given that these are large consortia grants, making a distinction between fundamental and translational/applied research is more challenging but there seems to be an

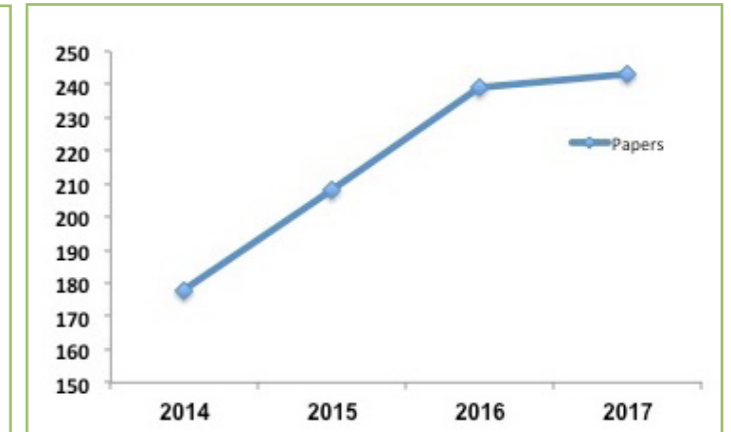

Figure 4: Numbers of original journal articles published between 2014-2017 that include research on Arabidopsis by UK plant scientists. NCBI PubMed was searched with the following parameters: Arabidopsis[Title/Abstract] AND UK AND "journal article"[Publication Type] AND YEAR[DP] NOT "review"[Publication Type].

even split between projects of either type. These projects usually support 3 years of postdoctoral research so it is possible that a successful ERA-CAPS applicant will be less motivated to submit a Responsive Mode proposal over this period. This could in part contribute to a small decline in Responsive Mode applications to research committee B.

An additional concern involves the fallout from Brexit and the future availability of ERC grants to UK plant scientists. Since 2014 thirteen UK-based plant scientists have received Starting, Consolidator or Advanced ERC grants amounting to approximately €35M and each of these proposes to undertake a significant proportion of research using Arabidopsis. If the UK does not participate in the next FP9 and other EU funding mechanisms then this clearly jeopardises a significant amount of support for fundamental plant science. The uncertainty around the post-Brexit role of UKRI prevents the BBSRC making any predictions regarding possible

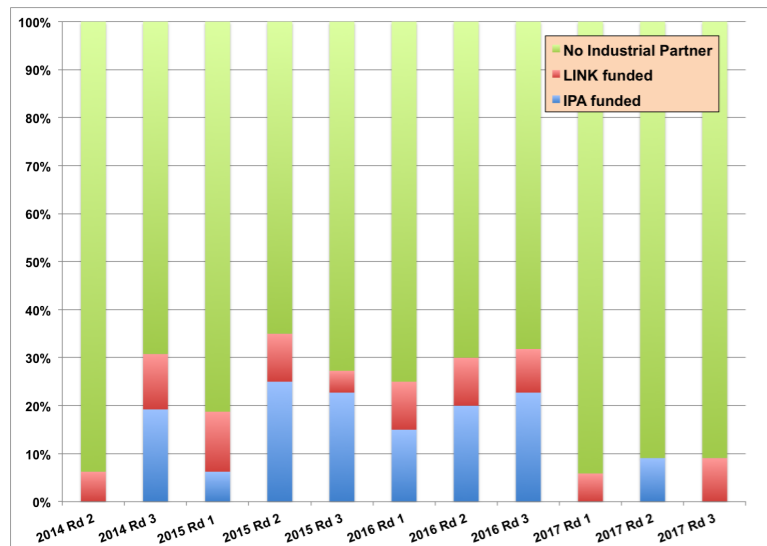

Figure 4: Number of successful LINK or IPA grants as a percentage of the total number of grants funded by Research Committee B in each grant round between 2014-2017. A description of IPA and LINK grants can be found at <https://www.bbsrc.ac.uk/funding>

supplementation of the funding pool if the opportunities to apply for EU funding disappear. We all continue to watch the slowly developing Brexit situation with some trepidation.

Although other funding opportunities for plant science researchers are available, these do not appear significant enough to explain the decline in Responsive Mode applications to Research committee B.

- Is there a problem with perception of BBSRC funding for fundamental plant science?

The majority of fundamental plant science research has used Arabidopsis as a model organism. However, GARNet identified a perception within the UK plant science community that the BBSRC prioritise funding other plant research ahead of Arabidopsis proposals. The GARNet Advisory Committee was assured by the BBSRC that this is not true and that they fund world-class bioscience of any type irrespective of the experimental organism.

The above perception may in part be due to a lack of understanding within the plant science community and by extension Committee B, of what IMPACT means for grant proposals. 'Impact' is an important aspect of any grant proposal as well as being a key component of the UK Research Excellence Framework (REF)n. However the BBSRC makes the case that all 'Impact' is not equal. Whereas REF-able 'Impact' usually refers to real-world applications of research outputs, the BBSRC Responsive Mode impact statement is assessed differently. Here 'Impact' can also refer to a longer-term fundamental contribution to a particular research area. If the proposal elucidates key questions that change the way we think about a biological problem then its long-term impact on a research area can be considerable and perfectly appropriate for the BBSRC impact statement.

GARNet Advisory Committee members were unsure whether this message is being strongly conveyed. In GARNet's experience many proposals include unnecessary portions of translational or applied research within grants that are clearly focused on a fundamental topic in order to accommodate a strategic component. The BBSRC are clear that inclusion of a translational or applied component is not a necessary requirement for its support of world-class proposals on fundamental plant science but does encourage the addition of an applied component if it is appropriate for the suggested research.

Related topics relevant to an assessment on the level of support for plant science applications for responsive mode funding.

- What is the current status of Research Committee Panel membership?

In recent years the research expertise present on Research Committee B may have been disproportionately distributed between fundamental versus translational/applied plant scientists. So how can a better balance of research expertise on the committee be achieved? In 2010 GARNet had similar discussions with the BBSRC about levels of grant funding. Alf Game, the then Deputy Director of Research for Innovation and Skills, prepared a comment piece for the GARNish newsletter that urged members of the GARNet community to apply to serve on grant panelsp.

Over the following 7 years it appears that this situation has not greatly changed. BBSRC emphasised the importance of participating in the evaluation process, first by agreeing to review grants and also by becoming members of Research Committees. The GARNet Advisory Committee suspects that the reduced involvement of fundamental researchers with Research Committee B might be due to a vicious cycle wherein the decline in funding levels decreases the willingness of fundamental researchers to engage with the review and selection process.

Encouraging more fundamental plant science researchers to become involved with committee membership could potentially arrest this cycle. The annual application process to join the BBSRC Pool of Experts usually occurs in the spring and is currently open for applicationsq.

- Do the successes of LINK and IPA grants reduce the available pool of funding for fundamental plant science?

The numbers of successful proposals that support fundamental plant science is connected to the level of success of BBSRC IPA and LINK grants. Given their industrial links these grants almost exclusively fund translational or applied research. Since 2014, the average success rate for these grants is 50% (IPA, average number of submissions per round is 5.6) or 70% (LINK, average number of submissions is 2.8), which is significantly above the overall success rate across Responsive Modes. Figure 5 shows that from 2014 to 2017 between 9- 35% of total grants funded in each round via BBSRC Research Committee B are either IPAs or LINKs. This demonstrates that in many Responsive Mode rounds these more translational or applied awards remove a significant pool of funding that might otherwise be available to support fundamental plant science proposals.

- Can plant-science proposals be submitted to other research committees?

A final discussion topic involved community experiences in which plant science-focused proposals submitted to Research Committees A, C or D have been moved to Committee B. Anecdotal evidence indicates that in some cases this appeared to have happened without the knowledge of the submitting PI. While the BBSRC indicated they retain the right to transfer proposals between committees to match remit, they agree such decisions should be communicated to the PI before transfer takes place. The BBSRC will investigate why in some cases this has not occurred and in future strives

to contact all affected PIs. The BBSRC also insists that plant-based proposals are welcome to be submitted to any Committee that is the best fit for the proposed program of research.

Recommendations

1. GARNet and other UK plant science stakeholders to spread the message that the BBSRC is 'open-for-business' to fund world-class grants based on fundamental plant science, including Arabidopsis-only research.

2. GARNet and other UK plant science stakeholders to encourage the academic community to review Responsive Mode grants and to apply to join Research Committees. Currently, this is a particularly important action point for fundamental plant scientists.

3. GARNet uncovered considerable confusion over what can be considered 'Impact' within Responsive Mode proposals. We recommend that BBSRC circulates updated information to potential applicants and Research Committee panel members to clarify what exactly can be considered as 'Impact'. The BBSRC is providing a piece on this topic for GARNish issue 29, published in Summer 2018.

4. Plant scientists are encouraged to submit their proposal to Research Committee B, but where more appropriate for the proposed research program they are also invited to submit to any of the other Research Committees. Should BBSRC deem it necessary to transfer proposals between committees, they will provide applicants the choice to withdraw their proposal.

5. BBSRC to advise potential applicants that world-class fundamental research is appropriate to be included in relevant GCRF applications, provided that it includes a clear long-term path toward a demonstrable benefit in an ODA country.

6. Given the success of IPAs, we recommend BBSRC reassesses the criteria for evaluating these grants. BBSRC could look into the possibility of capping the number of successful LINK/IPA proposals to a reasonable proportion of funded applications within a single grant round. Grants of sufficient quality would be encouraged to reapply in subsequent funding rounds if they do not fit under the cap in any one round.

7. Plant scientists are encouraged to engage with BBSRC to suggest areas that are relevant for special grant calls. The BBSRC has some flexibility to use Newton Fund and GCRF calls to respond to novel areas of research interest if there is a demonstrable relevance to the aims of these funds.

References and notes

a- The GARNet grant has been continuous supported since 2000 through BBSRC Responsive Mode funding. It has had an emphasis on supporting technologies that enable advances in fundamental research with an historic focus on the use of Arabidopsis thaliana. The current GARNet PI is Professor Jim Murray at Cardiff University and the activities of the full time GARNet Coordinator are advised by academics elected from the UK plant science community. Over the lifetime of the grant the large majority of academics on the GARNet advisory committee undertake fundamental rather than applied research, most using Arabidopsis as their primary research organism.

b- <https://www.bbsrc.ac.uk/about/governance-structure/committees/committee-b/>

c- GARNet recognizes that the Leverhulme Trust plays an important role in funding high risk, "blue sky" plant science projects and has been an increasingly key provider of last resort for many fundamental plant science projects deemed unfundable at Committee B.

d- <https://www.bbsrc.ac.uk/funding/post-application/awarded-grants/>

e- Outside of responsive mode there is a current opportunity to apply for a sLOLA award that is focussed on Frontier Bioscience and would be extremely applicable for plant scientists who work on fundamental topics. <https://bbsrc.ukri.org/funding/filter/lola/>

f- <https://www.garnetcommunity.org.uk/reports>

g- Data provided by Professor Sean May, director of the Nottingham Arabidopsis Stock Centre and a member of the GARNet advisory committee.

h- arabidopsisresearch.org/images/publications/mascreports/

i- <https://bbsrc.ukri.org/about/governance-structure/committees/committee-pool-membership/join-our-pool-of-experts-research-committee-e-follow-on-fund-committee/>

j- <http://www.rcuk.ac.uk/funding/gcrf/>

k- <http://www.eracaps.org/joint-calls/era-caps-funded-projects>

l- <https://erc.europa.eu/>

m- <https://www.ukro.ac.uk/Pages/brexit.aspx>

n- <http://www.ref.ac.uk/>

o- <https://bbsrc.ukri.org/funding/apply/application-guidance/pathways-impact/>

p- https://www.garnetcommunity.org.uk/sites/default/files/newsltr/garnish_jun10.pdf

q- <https://bbsrc.ukri.org/about/governance-structure/committees/committee-pool-membership/join-our-pool-of-experts-research-committee-e-follow-on-fund-committee/>

r- Grants of this type require an industrial partner who agrees to fund either 10% (IPA) or 50% (LINK) of the total cost.

s- On the four occasions that more than four LINK grants have been submitted during a single grant round only 50% of the grants were funded.

What is IMPACT according to the BBSRC

Rocio Gaudioso-Pedraza
Strategy and Policy Officer,
Frontier Bioscience
BBSRC



Rocio.GaudiosoPedraza@bbsrc.ac.uk

BBSRC as part of UKRI is committed to supporting excellent science and to realising the maximum impact of the research it funds. This benefits not only the taxpayer but also the research base, since it helps BBSRC make the case for continued government investment in research.

So what is Impact?

Impact is the effect that your research has beyond your lab. Impact can materialise in many different ways, and it is specific to each project, so it will be as varied and wide as your own research. Impact is not the same as applied research; both applied and fundamental research have impact and researchers should identify the best routes to achieve it. Impact can involve academic, economic or societal drivers which will vary depending on the nature of the research being undertaken (Figure 1).

Some ways that excellent research can have an impact include:

- Knowledge: research contributes to the understanding of basic questions in biosciences and scientific advances, and the wider body of scientific knowledge available to researchers.
- People: research contributes to long-term training of the research base that will contribute in

future scientific developments.

- Society: research contributes to improvements in health, quality of life, and international development.
- Economy: research contributes to wealth creation, encourage investments, new companies and/or new products and procedures.
- Policy: research contributes to development of new policies or guidelines, by providing an evidence base and answering key policy questions.

How do I write a good Pathways to Impact statement?

It is important not to confuse the 'Pathways to Impact' statement with long term implications of research. 'Pathways to Impact' need to be project-specific and outcome-driven, you should pay special attention to identify all interested parties and to plan how you can engage with all of them. The most common issues are failure to comprehensively consider different types of impact route, failure to identify specific goals and outcomes, and failure to have a clear plan of how impact activities will be delivered, by who and when. Activities identified need to be project-specific rather than generic activities.

How is impact factored into peer review decision making?

Pathways to Impact are an important part of any Research Council application for funding and can make the difference between two equally scientifically excellent grant proposals, so is it not trivial to get it right. No matter where down the translation line your research is you should explore and consider the general impact that your

Impact can be varied.....

.....is about more than just IP, products and spin outs



Figure 1: Examples of the variety of ways that excellent research impact can materialise

research could have in the future when applying for funding.

continue delivering funding, focussing on research excellence across its diverse remit.

What is the relationship between impact and BBSRC's strategy?

BBSRC highly values the contribution that excellent fundamental research makes in advancing a research field. It is important not to confuse research impact with aligning with BBSRC strategic priorities! While all researchers need to consider the potential impact of their research and the best way to explore it, not all fundamental research needs to have short-term outcomes directly linked to strategic priority areas, such as crop improvement. Academics are encouraged to design their research in the most appropriate way in order to achieve their objectives. BBSRC will

Funding News

Control of seed size and yield by vernalisation.

Steve Penfield
John Innes Centre
steven.penfield@jic.ac.uk

Many researchers have focussed on the potential of extreme weather to disrupt crop yields, and noted that climate change is likely to affect yields by increasing the frequency of extreme weather events. However, a quick look at historical data shows that there is considerable inter-annual variation in yield in some crops, even in the absence of extreme weather. Currently our ability to understand the impacts of climate change on agricultural productivity is limited primarily by our understanding of the mechanisms by which weather variation impacts crop development, leading to yield changes.

Of particular interest to us at the John Innes Centre is the UK winter rapeseed crop, which varies in mean yield between 3 and 4 tonnes per hectare each year. This variation by 25% of the



Penfield: Interrupting chilling in winter rapeseed field plots at the 110ha Church farm owned by the John Innes Centre at Bawburgh, Norfolk. By manipulating temperature in the field we will be testing why December chilling is important for high winter rapeseed yields in the UK. Photo credit: Carmel O' Neill

total crop value is worth around £200 million to the UK economy each year, but the factors driving this yield variation have been unclear.

Using statistical analysis of rapeseed Recommended List trials run by the Agriculture and Horticulture Development Board (AHDB) we have discovered that much of this yield instability is driven by the extent of winter chilling received by the plants in the period running up to Christmas day. Cold Decembers are associated with high yields the following summer, and very warm Decembers with poor performance over the whole country. Our hypothesis is that this effect is related to vernalisation, and this view is supported by preliminary genetic evidence. This BBSRC-funded project coordinated by Steven Penfield and Judith Irwin aims to understand the mechanism by which early winter chilling promotes high yields, and in this way develop strategies for increasing resilience in the UK winter rapeseed harvest.

The John Innes Centre is currently developing a new experimental farm in Norfolk, and one of the capabilities we have developed is the ability to apply heat to field trial plots over

winter, and monitor the effects on crop development and crop yields. This is an excellent way to bridge the gap between work in controlled environments and glasshouses and test how temperature variation in the field is likely to effect crop outputs

at landscape scales. Using this facility we will be able to test how and why chilling at particular times of year is linked to yield, and we will be able to exploit the close relationship between rapeseed and Arabidopsis to test these hypotheses in a timely manner.

The ultimate goal is to understand the molecular basis of plant seasonal behaviour, and understanding how to optimise plant genetics for different environments to maximise yield. Although we are working in a major crop species our hope is that the results will tell us much in general about plants adapt to growing in temperate environments with more or less winter chill, and improve our understanding of the implications of climate change for UK agriculture.

UK Government funds new National Plant Phenotyping Network

Tony Pridmore
tony.pridmore@nottingham.ac.uk

Technology Touching Life is a joint initiative between the UK's Medical Research Council (MRC), Biotechnology and Biological Sciences Research Council (BBSRC) and Engineering and Physical Sciences Research Council (EPSRC) that aims to harness new and emerging developments from the engineering and physical sciences to advance discovery research in the life sciences.

The initiative recently announced six network awards, with a total value of £3M, including a new national network in crop phenotyping

PhenomUK, a network led by Professors Tony Pridmore (UoN) and Malcolm Hawkesford (Rothamsted Research), aims to:

1. ensure that UK scientists have access to the technological capabilities needed to drive world-leading basic discovery research in the plant, crop and agricultural sciences
2. provide the deeper understanding of national plant phenotyping capabilities, needs and opportunities required to allow the UK to gain maximum benefit from international initiatives such as EMPHASIS.

<https://emphasis.plant-phenotyping.eu/>



The network will be multidisciplinary, encouraging engineering, physical and computer scientists to work alongside plant biologists to develop automation, sensor and data analysis technologies that can profile plants in a variety of environments.

PhenomUK's £500K budget will provide the usual networking activities - an annual UK conference on Crop Phenotyping, web presence and issue-based and outreach workshops – but also includes funds with which the network will support pilot projects and feasibility studies examining the potential of emerging technologies in crop phenotyping.

Hidden in a G-box: Using Ara-BOX-cis to understand the G-box regulatory code in Arabidopsis

Daphne Ezer
dezer@turing.ac.uk



University of Warwick
Department of Statistics
The Alan Turing Institute
Sainsbury Laboratory, University of Cambridge

As biologists, we often want to identify which transcription factors (TFs) regulate a gene or set of genes we find interesting. For instance, we might be interested in the regulation of a gene whose mutant has a peculiar phenotype or a set of genes that have shared expression patterns under a certain environmental condition. One strategy for identifying possible regulatory TFs is to look for specific binding sites upstream of the genes of interest. However, not all TFs have known binding sequences and there can be many TFs that bind to very similar sequences. This is especially a problem for plant researchers, since plants have very large families of recently divergent TFs that can bind to similar conserved cis-regulatory elements (Shiu *et al.*, 2005). For instance, there are approximately 200 TFs that come from families that are capable of binding to the sequence CACGTG (the G-box), and there are about 2000 genes with perfect G-boxes in their promoter sequences. In our recent paper (Ezer *et al.*, 2017b), we provide web resources to help generate hypotheses about possible TF-gene interactions, specifically in the case of G-boxes.

To infer regulatory relationships, we used hundreds of RNA-seq experiments, across different time points and temperatures, in various mutant backgrounds that are relevant to some of the main G-boxes-related biological processes. Three different algorithms were used to infer the

regulatory network, and the results were averaged, a technique that produces more accurate results than any one algorithm on its own (Marbach *et al.*, 2012).

The entire network is available on www.araboxcis.org

Any gene with sufficient expression in seedling Arabidopsis will be in the network if it is a bHLH or bZIP or it contains a perfect G-box within 500bp of its transcription start site. There are three main modes for exploring the network—you can look at the network surrounding a single gene, a group of genes, or the entire set of genes. We will consider each of these in turn.

Firstly, you can centre the network on a single gene of interest ('single gene' tab), via its TAIR ID (i.e ATxGxxxx). The sub-network's genes are colour-coded by the time of day in which they are primarily expressed. By hovering over the gene name, you can see a short gene description, and it is also possible to click on genes upstream or downstream to traverse through the network. Figure 1A shows the network centred on PYE, a gene involved in metal homeostasis.

Secondly, a biologist might have a set of genes that interests them. For instance, in a previous paper we found a G-box appearing under our ChIP-seq peaks for LUX—an element of the Evening Complex—even though LUX cannot bind to G-boxes (Ezer *et al.*, 2017a). Ara-BOX-cis can help us identify other TFs that might associate with the complex. In the 'multiple gene' mode, genes of interest are inputted, one per line. Then, Ara-BOX-cis will list the subset of genes found in the network, as well as the all upstream or downstream genes and a pie chart summarising temporal expression patterns. The results for LUX targets is shown in Figure 1B.

Finally, the entire network can be viewed under the 'browse' tab, also colour-coded by time-of-day. Also, you can search for G-boxes

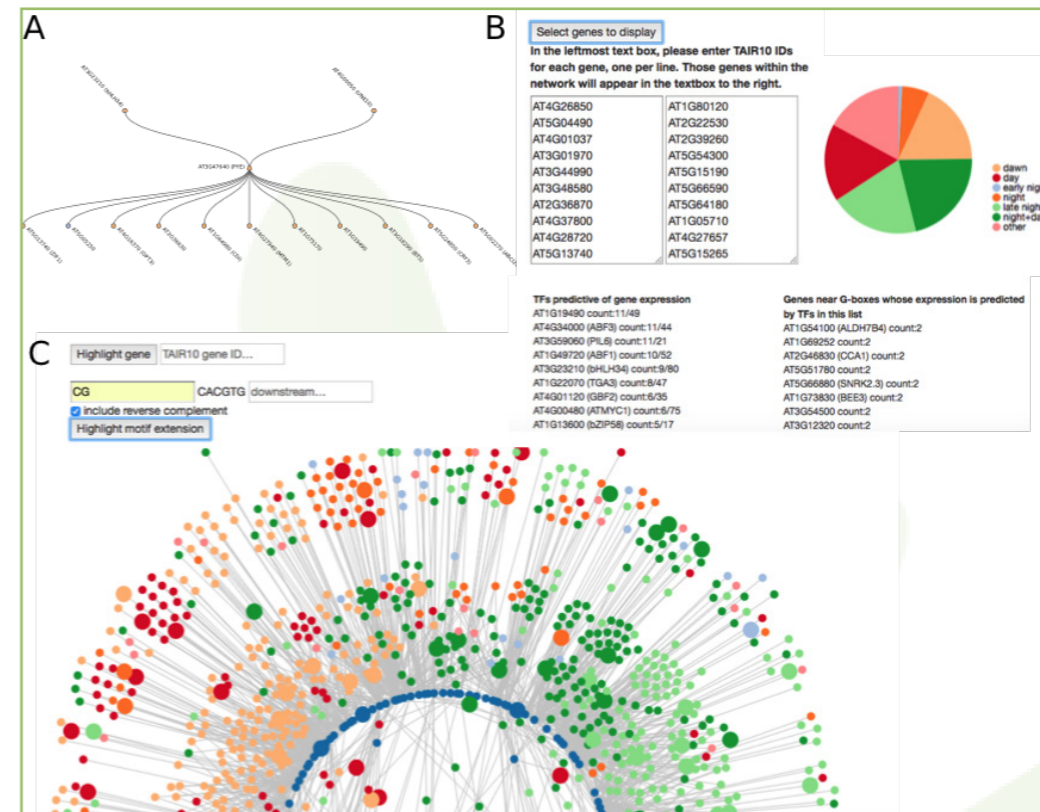

Figure 1: The Ara-BOX-cis website (A) The single gene mode, centred on PYE. (B) The multiple gene mode, showing genes near LUX binding sites. (C) The 'browse' mode of the website with genes near G-boxes with a CG flanking sequence highlighted (i.e. nodes enlarged). www.araboxcis.org

with extended motifs, like CACGTGCG or AAACACGTGAAA—see Figure 1C. This is an important feature, since flanking DNA sequences affect *in vitro* bZIP binding (O'Malley *et al.*, 2016; Ezer *et al.*, 2017b).

In response to user feedback, we've added a few special sections on the website for plant scientists who are interested in genes that don't quite fit into the strict criteria for inclusion into the original network. For instance, a gene might have a G-box less than 1000bp from the transcription start site, but over 500bp away. Also, a gene might have a similar sequence to a G-box, like GACGTG instead of the canonical CACGTG. For this, we provide an expanded network, viewable in 'single gene' or 'multiple gene' modes.

However, one of the strengths of the Ara-BOX-cis network is that it only includes genes that are highly likely to be regulated by a G-box, meaning that it is less likely to include false-

positive relationships than the expanded network.

It can be a major roadblock for a plant biologist when they find that their gene of interest is regulated by a highly conserved cis-regulatory element that can be bound by many different TFs. If there is an obvious candidate for a regulatory TF, this can be easily confirmed experimentally; however, it would be impractical to test more than a handful of possible candidate TFs. We hope that Ara-BOX-cis will help researchers narrow down a list of possible TF candidates in these circumstances, and that further networks can be made to handle other highly conserved binding sites, like Heat Shock Elements and W-boxes.

Bibliography

- Ezer D, Jung J-H, Lan H, Biswas S, Gregoire L, Box MS, Charoensawan V, Cortijo S, Lai X, Stöckle D, *et al* (2017a) The evening complex coordinates environmental and endogenous signals in Arabidopsis. *Nat Plants* 3: 17087
- Ezer D, Shepherd SJK, Brestovitsky A, Dickinson P, Cortijo S, Charoensawan V, Box MS, Biswas S, Jaeger KE, Wigge PA (2017b) The G-box transcriptional regulatory code in Arabidopsis. *Plant Physiol.* doi: 10.1104/pp.17.01086
- Marbach D, Costello JC, Küffner R, Vega NM, Prill RJ, Camacho DM, Allison KR, Consortium D, Kellis M, Collins JJ, *et al* (2012) Wisdom of crowds for robust gene network inference. *Nat Methods* 9: 796–804
- O'Malley RC, Huang S-SC, Song L, Lewsey MG, Bartlett A, Nery JR, Galli M, Gallavotti A, Ecker JR (2016) Cistrome and Epicistrome Features Shape the Regulatory DNA Landscape. *Cell* 165: 1280–1292
- Shiu S-H, Shih M-C, Li W-H (2005) Transcription factor families have much higher expansion rates in plants than in animals. *Plant Physiol* 139: 18–26



Commentary on

Variable effects of C-terminal tags on FLS2 function - not all epitope tags are created equal. *Plant Physiology*.

<https://doi.org/10.104/pp.17.01700>

Charlotte H. Hurst, Dionne Turnbull & Piers A. Hemsley

p.a.hemsley@dundee.ac.uk

Epitope tagging is now such a routine part of molecular, cellular and biochemical studies that it is easy to forget that epitope tags are non-native additions to a protein's structure. Although the tags typically used for subcellular localisation (GFP variants, mRFP, etc.), western blotting studies (FLAG, HA, MYC, etc.) or protein purification (6xHIS, TwinSTREPII, etc.) are assumed to be benign, possessing no known enzymatic, scaffolding or other biological role that could be expected to alter protein function, they still add spatial bulk to a region of the protein, can affect how a protein folds and may change the order/disorder composition of a protein region.

While working with FLS2 we were surprised to discover that none of our in-house generated FLS2 C-terminal fusions complemented the *fls2* mutant phenotype when expressed at levels similar to endogenous FLS2. By comparison, FLS2 expressed from an identical construct but without any tags achieved 100% complementation in every line tested [1]. BAK1, the FLS2 and BRI1 co-receptor, was reported to be similarly affected in function by epitope tags when examining FLS2 responses but was unaffected in BRI1 responses [2]. Recent work also suggests that Erecta function is impaired by the addition of luciferase to the

C-terminus [3], although this is not explicitly stated. A brief and non-exhaustive examination of the plant literature shows that epitope tag effects on protein function are remarkably common, but the importance and impact of this is underappreciated and sometimes appears to be brushed aside or ignored entirely. Reported examples include; Phototropin1-GFP being less functional than wild type [4], HA- or GFP tagged B-tubulin resulting in a range of phenotypes including altered microtubule dynamics and right-handed helical growth [5], tags on either end of the potato resistance protein R3a abolishing the hypersensitive response following Avr3a effector recognition [6], while the chloroplast division factor MinD1 localised similarly when fused to either -2xHA or YFP but only the -2xHA version complemented the mutant phenotype [7].

Short N- or C- terminal epitope tags (i.e. the tag is the first or last part of the polypeptide, respectively) such as FLAG, MYC or HA generally introduce a region of disorder. This can lead to accelerated protein turnover, mediate abnormal protein-protein interactions or promote aggregation [8]. In addition tags may alter posttranslational modification sites or processing signals if inappropriately placed at the C-terminus (e.g. prenylation, GPI/GIPC anchor addition) or N-terminus (secretory signals, transit peptides, etc.) and block correct function or targeting of the protein.

However, these are generally easy to predict computationally and avoid. Less easy to predict is the possibility of disrupting or inadvertently introducing sites for dynamic or poorly characterised post-translational

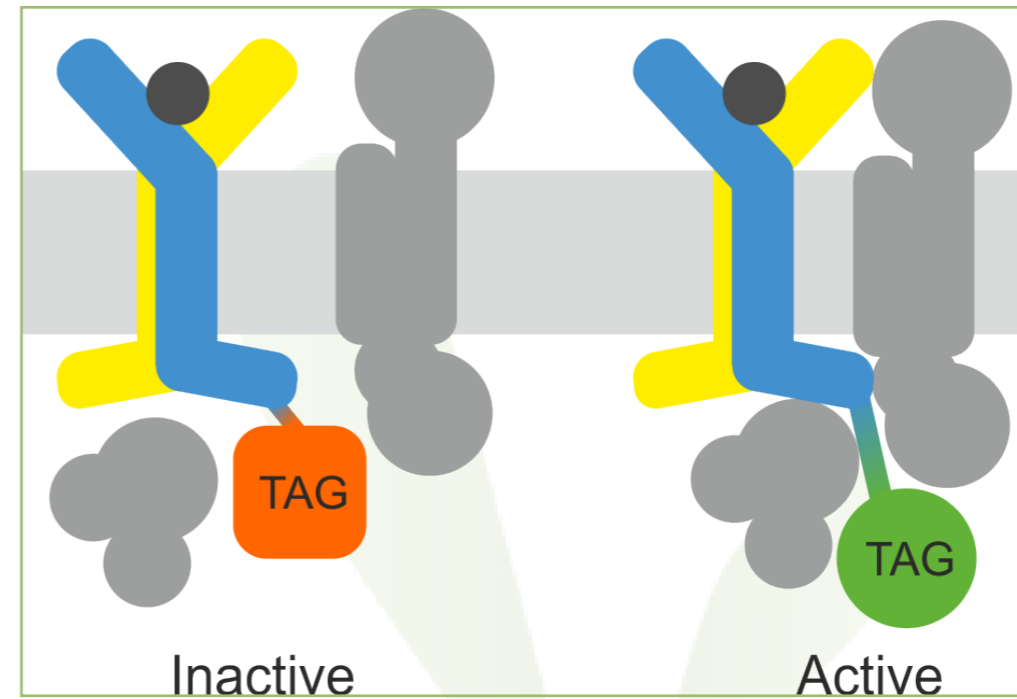

modifications such as phosphorylation, ubiquitination, nitrosylation, glutathionylation, SUMOylation or S-acylation.

Jellyfish and coral fluorescent proteins, frequently used as dual function imaging and purification tags, are dimers or higher order multimers in nature. Extensive work has been done to produce monomeric mutant variants, although with differing success, and it is worth noting that the GFP forms found in the commonly used Ghent [9] (EGFP), pEarlyGate [10] (mGFP5) and pMDC [11] (mGFP6) series of gateway vectors do not contain dimerization disrupting mutations. An in-vivo screen of different fluorescent proteins using changes to mammalian cell ER architecture as a read out indicates that deleterious effects of dimer/oligomerisation can be observed in 1% (mEGFP), ~10% (mTurquoise, mCerulean), ~25% (EGFP), 65% (Venus, Citrine) to 100% (TurboRFP, DsRed2) of cells [12]. A wide ranging report indicated that 65% of tested GFP fusions in mammalian cells showed only similar (45%) or totally dissimilar (20%) localisations when compared to

immunohistochemical analysis. Possibly more importantly, when the same proteins were analysed with either N- or C-terminal GFP fusions, only 40% showed identical localisation while 25% were completely dissimilar [13]. This really brings home the message that not just epitope fusions, but also their placement on a protein, can have profound effects. While these limitations may be well known to cell biologists, biochemists using GFP as a multifunction tag may be

inadvertently confounding their experiments by altering localisation, stoichiometry or interactions through the use of "inappropriate" fluorescent fusion tags.

Even in our analysis it became evident that different tags and linker sequences impaired FLS2 function to differing and largely unpredictable extents. For instance, FLS2 tagged at the C-terminus using gateway destination vectors containing either EGFP or mGFP6 [9, 11] were less functional than FLS2 linked to EGFP using a 3xMYC spacer [14]. Interestingly, EGFP and mGFP6 tagged FLS2 function is impaired in different ways suggesting that each tag/linker combination affected individual FLS2 mediated processes to different degrees. A 3xHA tag fused to FLS2 [15] with no linker at all essentially abolished FLS2 function. Interestingly the 3xHA tag also impaired BAK1 function to a much greater degree than any other tag [2] suggesting that the HA tag is much more disruptive than would be expected given its 27 amino acid size. Each repeat

of the HA tag contains 2 prolines and given the effects of prolines on peptide structure the 3xHA tag may be relatively inflexible. Being placed immediately adjacent to the FLS2 C-terminal amino acid may therefore impair function more than if a linker had been present.

Just as important as the tags are the linkers connecting them to your protein of interest. Linkers have been shown to affect protein stability and folding, with different linkers having different effects, as well as the more expected role of separating the tag from the protein of interest. Linkers in nature, found in multi-domain proteins, tend to be rigid, either through the presence of prolines to maintain a specific linker conformation for structural purposes or α -helices to maintain spatial separation. Alternatively, linkers can be flexible, through the presence of mostly glycine, serine or threonine residues [16]. The length and flexibility of the linker used can therefore determine whether the fusion tag may interfere with your protein of interest, although there seems to be little empirical evidence to say what the best route is in a given circumstance.

Taking all of this into account highlights how critical it is to validate the functionality of epitope-fusions before use. In Arabidopsis work this is usually fairly trivial due to the availability of mutants in genes of interest and the ease of transformation for complementation testing. However, even here there are pitfalls. As we found, each epitope tag can affect different outputs to different degrees [1], therefore a range of phenotypes should be assessed before complementation is declared.

In addition, if an epitope markedly reduces functionality but the transgene is driven by a strong promoter or the tag increases protein stability, dosage compensation may mask the epitope induced functional defects [17]. It is therefore probably best to use as much of the native genetic context as possible for constructs. Given the high fidelity of modern DNA polymerases, and seamless cloning strategies like GreenGate [18] or GoldenGate [19], this should not be an issue. In addition there may be gain-of-function phenotypes caused by a tag, such as observed for B-tubulin [5], that needs to be tested and controlled for. If a terminal tag proves deleterious there is still the possibility of introducing tags internally. This is aided by structural data, but software prediction of disordered regions may also be used to indicate potential sites where an epitope tag could be substituted in.

However, this approach does necessitate a range of constructs to be made to identify the best site. If resources allow, the generation of an antibody against the protein of interest may actually be most cost effective and accurate in the long run. This allows for assessing altered protein expression, turnover or cleavage, may allow for immunohistochemical comparisons with fluorescently tagged protein forms and allow for comparisons of interactors between native and tagged versions of a protein. If all data correlates then it may be possible to proceed with analysis of tagged forms of a protein (e.g. comparisons of mutant forms of a protein).

- Hurst, C.H., *et al.*, Variable effects of C-terminal tags on FLS2 function - not all epitope tags are created equal. *Plant Physiol*, 2018.
- Ntoukakis, V., *et al.*, Cautionary notes on the use of C-terminal BAK1 fusion proteins for functional studies. *Plant Cell*, 2011. 23(11): p. 3871-8.
- Kosentka, P.Z., *et al.*, Identification of critical functional residues of receptor-like kinase ERECTA. *J Exp Bot*, 2017. 68(7): p. 1507-1518.
- Sakamoto, K. and W.R. Briggs, Cellular and subcellular localization of phototropin 1. *Plant Cell*, 2002. 14(8): p. 1723-35.
- Abe, T. and T. Hashimoto, Altered microtubule dynamics by expression of modified alpha-tubulin protein causes right-handed helical growth in transgenic Arabidopsis plants. *Plant J*, 2005. 43(2): p. 191-204.
- Engelhardt, S., *et al.*, Relocalization of late blight resistance protein R3a to endosomal compartments is associated with effector recognition and required for the immune response. *Plant Cell*, 2012. 24(12): p. 5142-58.
- Fujiwara, M.T., *et al.*, Further evaluation of the localization and functionality of hemagglutinin epitope- and fluorescent protein-tagged AtMinD1 in Arabidopsis thaliana. *Biosci Biotechnol Biochem*, 2009. 73(7): p. 1693-7.
- Georgieva, M.V., *et al.*, Inntags: small self-structured epitopes for innocuous protein tagging. *Nat Methods*, 2015. 12(10): p. 955-8.
- Karimi, M., D. Inze, and A. Depicker, GATEWAY vectors for Agrobacterium-mediated plant transformation. *Trends Plant Sci*, 2002. 7(5): p. 193-5.
- Earley, K.W., *et al.*, Gateway-compatible vectors for plant functional genomics and proteomics. *Plant J*, 2006. 45(4): p. 616-29.
- Curtis, M.D. and U. Grossniklaus, A gateway cloning vector set for high-throughput functional analysis of genes in planta. *Plant Physiol*, 2003. 133(2): p. 462-9.
- Cranfill, P.J., *et al.*, Quantitative assessment of fluorescent proteins. *Nat Methods*, 2016. 13(7): p. 557-62.
- Stadler, C., *et al.*, Immunofluorescence and fluorescent-protein tagging show high correlation for protein localization in mammalian cells. *Nat Methods*, 2013. 10(4): p. 315-23.
- Mbengue, M., *et al.*, Clathrin-dependent endocytosis is required for immunity mediated by pattern recognition receptor kinases. *Proc Natl Acad Sci U S A*, 2016. 113(39): p. 11034-9.
- Dunning, F.M., *et al.*, Identification and mutational analysis of Arabidopsis FLS2 leucine-rich repeat domain residues that contribute to flagellin perception. *Plant Cell*, 2007. 19(10): p. 3297-313.
- Chen, X., J.L. Zaro, and W.C. Shen, Fusion protein linkers: property, design and functionality. *Adv Drug Deliv Rev*, 2013. 65(10): p. 1357-69.
- Hemsley, P.A., *et al.*, A proteomic approach identifies many novel palmitoylated proteins in Arabidopsis. *New Phytologist*, 2013. 197(3): p. 805-814.
- Lampropoulos, A., *et al.*, GreenGate---a novel, versatile, and efficient cloning system for plant transgenesis. *PLoS One*, 2013. 8(12): p. e83043.
- Engler, C., R. Kandzia, and S. Marillonnet, A one pot, one step, precision cloning method with high throughput capability. *PLoS One*, 2008. 3(11): p. e3647.

✿ Monogram 2018
John Innes Centre

24th-26th April,

Toby Barber

NIAB

toby.barber@niab.com

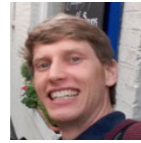

Science and community

Having worked at NIAB for a few years prior to starting my PhD, I had heard many a tale about the wonders of the Monogram conferences (and the nights out) and had managed to sneak into a few of the talks (and a free lunch) in 2016 when Monogram was held in Cambridge, but had never officially attended. I was fortunate this year in being awarded a GARNet travel grant to help with my conference costs, on the proviso that I write a short article on an aspect of the conference which I found interesting. This is actually quite a tricky task as there was so much to take in so I've decided to choose two aspects.

The first of these is bioinformatics, especially wheat bioinformatics. Being a novice and it being something which I'm going to have to learn, and soon, I started my week early with the hands-on workshop on Monday and the cereal bioinformatic session on Tuesday morning. In addition to these extra sessions the importance of bioinformatics was abundant throughout the talks and posters.

As many of you probably know, the wheat genome is MASSIVE, 17Gb with 21 chromosomes, each one larger than the whole Arabidopsis genome. Due to the size and complexity, lots of repetitive regions, whole genome sequencing is further behind than other crop species. The first reference, CSS, was released in 2014 and

was created by flow-sorting and sequencing each chromosome separately and assembled into a crude order. The TGACv.1 was released in 2017 and has replaced the earlier version due to its much higher coverage. The new IWGSC reference genome, RefSeq v1.0 is expected to be published within the next few months and there was a real sense of excitement about this. The new sequence has better coverage still with genes in their true physical order. The resources available for bioinformaticians (many of them free and with support available) are incredible. Visit wheat-training.com set up by the team at JIC to start your journey.

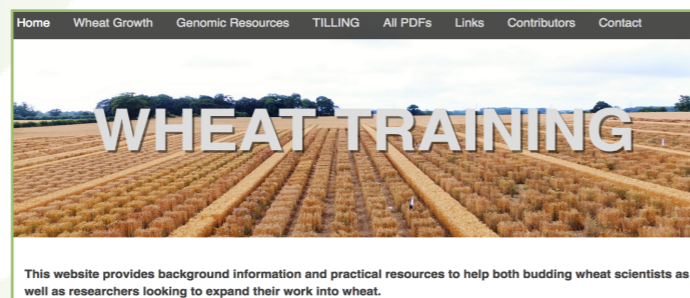

The second aspect is community. Since starting to work in the field of wheat [groans at own pun] I have interacted with many people from other institutes, academia and industry, so it was a great opportunity to catch up with some familiar faces and also to meet new people and talk about our respective projects and roles. The conference attracts world leading experts in many different aspects of small grain cereal science who were approachable and interested to talk to us lowly PhD students. This friendly atmosphere was really a stand out point for me of the conference and a great place to network and make connections for possible future collaborations. There was also a great uptake of social media during the talks and poster sessions, check out [#Monogram18](https://twitter.com/Monogram18) and [#Monogram2018](https://twitter.com/Monogram2018) and what can I say about the infamous meal and night out?

Well, for at least that part; what happens at Monogram, stays at Monogram.

Patrycja Sokolowska

Rothamsted Research

patrycja.sokolowska@rothamsted.ac.uk



Monogram 2018 at John Innes Centre in Norwich was the first, and so far the only conference I have been to since I have started my PhD. Monogram has the established reputation to be the best cereal research meeting in the UK, and it gathers the most experienced wheat scientists and breeders, as well as PhD students and young Postdoctoral researches. My colleagues who went to the Monogram last year said it was great, so I was very excited to go and experience it for myself. I was not disappointed!

The conference venue was located in a lovely surroundings of Norwich and the conference itself was brilliantly organised. Morning and afternoon sessions were grouped into focus blocks with clear themes, and although I found all the sessions interesting, due to the nature of my research, the Cereals Bioinformatics Session and Grain Development and Crop End Use Session were most useful for me. Apart from the variety of talks from invited speakers and PhD students, we also had a poster session, during which I had a chance to present my work. The session meant to last for one afternoon, but it extended into the whole duration of the conference (!), which was great, because we could talk about our work for longer! But Monogram is not only hard work! Our hosts in Norwich made sure that we have time to relax and have a chat with other attendees over a meal too. On the first day we enjoyed the barbeque and a drink, and the second day ended with a bit more formal dinner in the beautiful Assembly House.

The Monogram meeting proved to be a great place to meet peers working in a very similar field. Usually, even though I am lucky enough

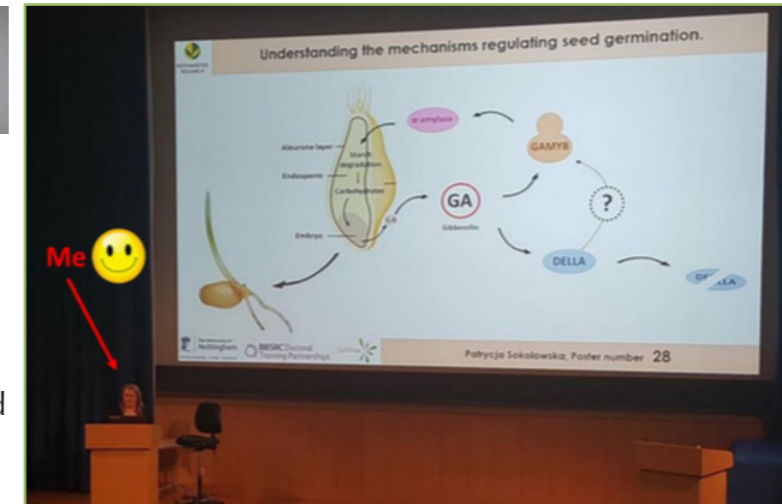

The author during her flash talk presentation, trying to lure people into visiting her poster

to be doing my PhD in a crop sciences-based research institute, where quite a lot of people work on wheat, I do not get a chance to exchange my experiences with students, simply because the project we are working on are very different. Monogram gave me an amazing opportunity to meet PhD students who use similar laboratory techniques and work on organisms closely related to wheat. We had a chance to talk about our research and exchange valuable experiences. I hope we will keep in touch and I am looking forward to reading their first publications.

Overall, these were very intense but informative and fruitful three days. I am very happy that I could be a part of this year's Monogram and I would recommend going to anyone working in the field of cereal research. I would like to thank GARNet for awarding me the travel grant to attend this conference, and making my expenses budget a little less tight! I am looking forward to the Monogram meeting in Nottingham next year!

Who knows, maybe I will have a chance to present next year!



Unleashing the Power of Automation for Plant and Microbial Science

Dr. Jose A. Carrasco
josecarrasco-lopez@earlham.ac.uk

Dr. Nicola Patron
nicola.patron@earlham.ac.uk

Synthetic Biology
Earlham Institute

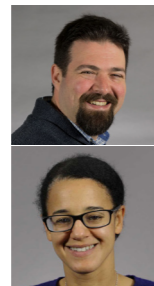

In 2012, the UK government established the £102M "Synthetic Biology for Growth" Programme to nurture the UK's growing synthetic biology sector and kick-start the UK's bio-economy. The research council's investment in key areas included strategic capital to bring academic expertise to bear on bottlenecks in 'DNA synthesis'. In 2015, Earlham Institute (EI) received £2m to establish a plant and microbe BioFoundry on the Norwich Research Park. This facility is now part of the Earlham Institute's National Capability in Genomics and is co-directed by Nicola Patron and Anthony Hall.

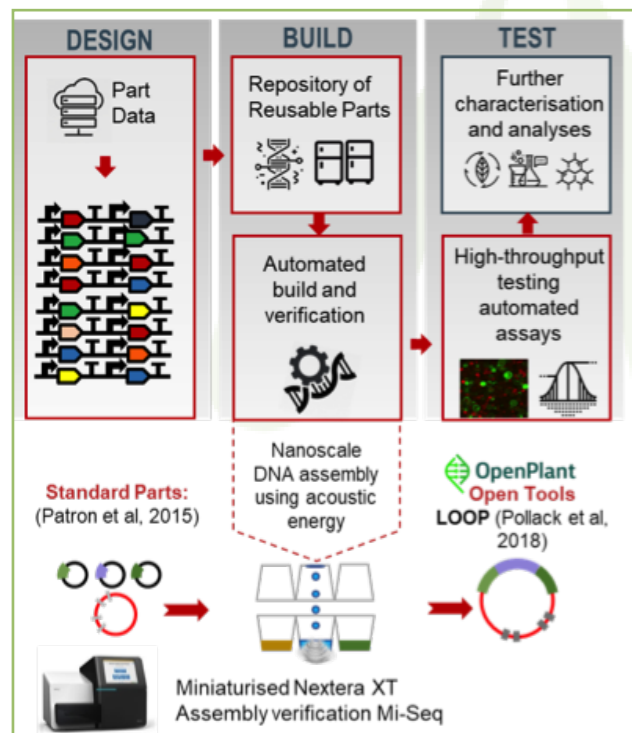

So, what is a BioFoundry?

Contrary to expectations, the UK BioFoundries do not have the capacity for *de novo* chemical synthesis of DNA. This is a service well-provided for by the private sector. Rather, the Foundries are suites of laboratory automation dedicated to high-throughput, automated workflows for:

- Assembling DNA molecules (up to genome scale)
 - Delivery of DNA to biological organisms (in synthetic biology, these are known as 'chassis'),
 - Where possible, interrogating the function of delivered DNA by rapid, quantitative phenotyping
- DNA Foundries are, basically, platforms for the UK bioscience community to perform large-scale experiments and benefit from local, multi-disciplinary expertise in synthetic biology, metabolic engineering, biotechnology and automation. This can help you to pursue large projects at lower cost, more efficiently and accurately.

Capabilities & Workflows

At the Earlham Foundry, we have implemented a nanoscale automated workflow for standardised DNA parts assembly using Type IIS restriction endonucleases (aka 'Golden Gate' assembly), complete validation by Next-Gen sequencing and automated delivery to microbial and plant cells. In Type IIS DNA assembly, digestion and ligation is a one pot, one step reaction, yielding recombinant plasmids that do not contain unwanted restriction sites, allowing both speed and precision.

We also provide access to the BioLector Pro microfluidic microbioreactor system. This system is able to perform high-throughput cultivation of microbes in batch or fed-batch modes, suitable for applications such as media screening and optimisation, strain-screening, anaerobic and microaerophilic fermentations, high-throughput protein expression or proteomic studies.

How Foundries reduce the cost of experimentation



Reaction volume: A typical cloning reaction volume in the Foundry is less than 1 μ L and may be transformed into just 2 μ L of competent cells.



Reliability & Robustness: People are not that great at pipetting, particularly in highly repetitive processes with multiple components in different combinations. It's far more reliable to program the robot and let it do its thing!



Re-use by standardisation: Standardised DNA parts can be assembled efficiently; the same construct can be reused in multiple experiments and any modification and variation is easily produced.



Economy of scale: We can't hide that doing 384 experiments costs more than doing 10 and some consumables for high-end robotics don't come cheap. However, most of the cost is in setting up a new automated workflow – the more you run it, the cheaper it gets.

To facilitate the exchange of scientific resources and protocols, we also serve as a repository and re-distribution point for large collections of DNA parts deposited under an Open Material Transfer Agreement (<http://openmta.org>). Additionally, we aim to provide training in Synthetic Biology approaches to experimentation.

How the EI DNA Foundry can help you

At the EI DNA Foundry, our aim is to minimize the pain and optimise the gain. We can couple automated design-build to downstream analyses by sending suites of engineered cells for genomic/transcriptomic analyses at the EI sequencing platform or to other facilities for proteomics/metabolomics. Alternatively, we can send the verified constructs back to you or to a plant-transformation platform, such as the BRAC facility at the John Innes Centre.

Our technologies (genome engineering, DNA assembly, DNA delivery, automatic colony picking, nanoscale liquid handling...), automation equipment and expertise in plant and microbial science are available to the UK plant and microbial research community to address questions that, for

most labs, are simply unworkable due to the scale of experiments required. In engineering, designing experiments to test how multiple variables work in concert is second nature. This approach can be used, for example, to find, in a single experiment, the sweet spot where the type of media, the promoter and temperature all work

together to give you the maximum amount of your longed-for special metabolite.

How to collaborate with the EI DNA Foundry

If you are interested in a collaboration with the EI DNA Foundry please contact DR. Jose A. Carrasco Lopez (Foundry Manager) by email at Jose.Carrasco-Lopez@earlham.ac.uk. You can find additional information on our web page Earlham DNA Foundry. Our working model is based on sustainability and honesty: if there is a better way to achieve your goals we'll let you know.

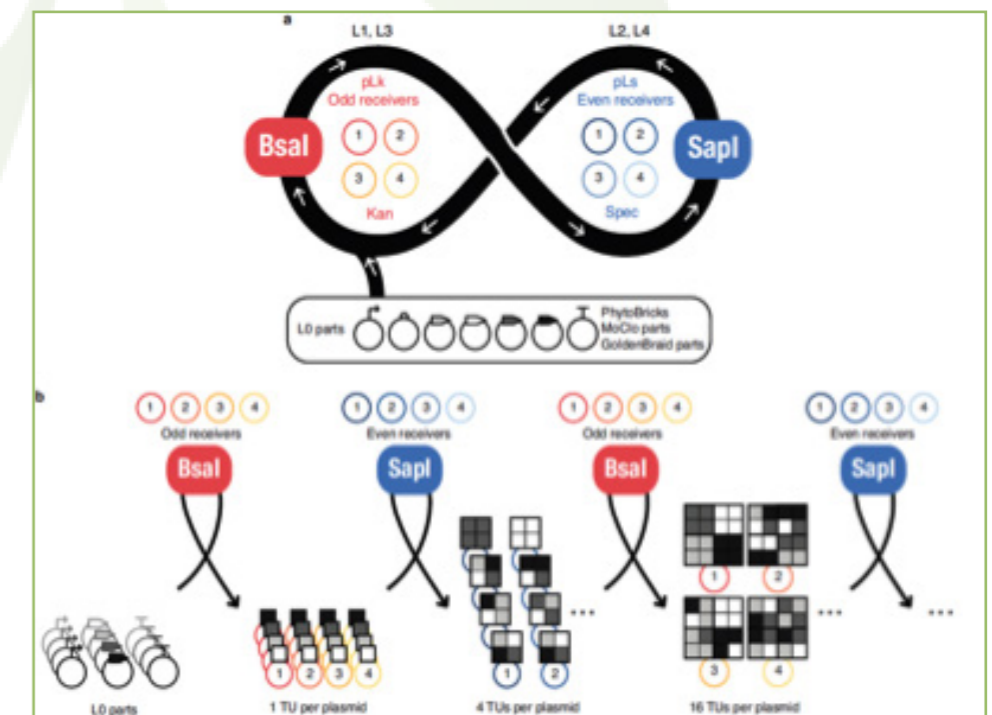



Spotlight on:

Royal Holloway University of London (RHUL)

Kindly compiled by Enrique Lopez-Juez

Royal Holloway (1879) and Bedford (1849) colleges pioneered higher education for women in Britain. Since their merger, and perhaps owing in part to the location of the beautiful Egham campus at the edge of Greater London, Royal Holloway has maintained and enhanced an active plant science (and related disciplines) core within the University of London. Not surprisingly, Arabidopsis and its genetic resources have also played centre-stage, but Royal Holloway has traditionally had a strong emphasis in biochemistry, encompassing primary (cell wall polysaccharides) and secondary metabolism, both with impactful industrial, biotechnological, engineering (seed biology) and plant defence implications.

The Centre for Plant Molecular Sciences includes about a quarter of the staff at the School of Biological Sciences, with interactions with colleagues in the ecology, environmental and biomedical centres and the Computer Science Department, with whom a Centre for Systems and Synthetic Biology was established. Work at Royal Holloway has a strong, varied support from the Research Councils, the EU, industry and international foundations, making secure and sustainable production of food and natural products an overarching goal for its researchers



Dr Laurence Bindshedler
Laurence.bindshedler@rhul.ac.uk



Molecular plant pathology and proteomics

In order to devise new strategies to control plant diseases that are major threats to food security, we focus on revealing key players of fungal virulence and host susceptibility during plant-fungi interactions. The current emphasis is on powdery mildews and major fungal pathogens of cereal crops.

To explain the biotrophic interaction of barley powdery mildew, *Blumeria graminis*, an effector-centric proteomics approach focusing on biotrophic structures has identified haustoria-specific effector proteins involved in *Blumeria* virulence. These effectors are investigated to identify host proteins that are targeted by effectors. To further reveal host proteins which are involved in resistance or favour susceptibility, we are investigating the proteome of the plant extra-haustorial complex.

To overcome challenges of working with biotrophs, an RNAi-derived, host-induced gene silencing workflow has been devised to validate effector gene function in virulence for cereal powdery mildews. Seeking new disease protection

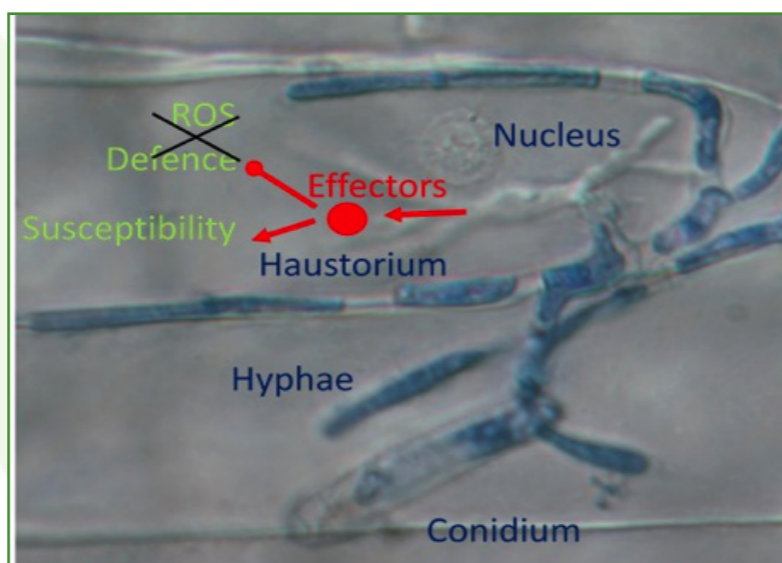

Bindshedler: Powdery mildew infection structures on barley epidermis wheat lines

strategies in crops, the methodology is being translated to other commercially-relevant fungal pathogens of wheat.

Prof. Laszlo Bogre
l.bogre@rhul.ac.uk



Plant growth signalling

How nutrient, energy and environmental factors impact on meristem activities is fundamentally important for crop productivity. The long standing interest of the Bogre lab is the signalling mechanisms that regulate cell proliferation and plant growth. One of our current focus is how the TOR-S6K growth signalling pathway regulates the RETINOBLASTOMA-RELATED protein complexes and the associated E2F transcription factors. In a collaborative project with the von Arnim lab we investigate the regulation of protein translation by TOR and its connection to the cell cycle.

With the Magyar and Ito labs we are characterising the evolutionary-conserved DREAM complex composition, targets and functions. We analyse these protein complexes to understand how light, carbohydrates, and environmental stresses, such as genotoxic stress, drought and heat, promote or restrict cell proliferation, regulate meristem maintenance, establish cellular quiescence or drive differentiation. In

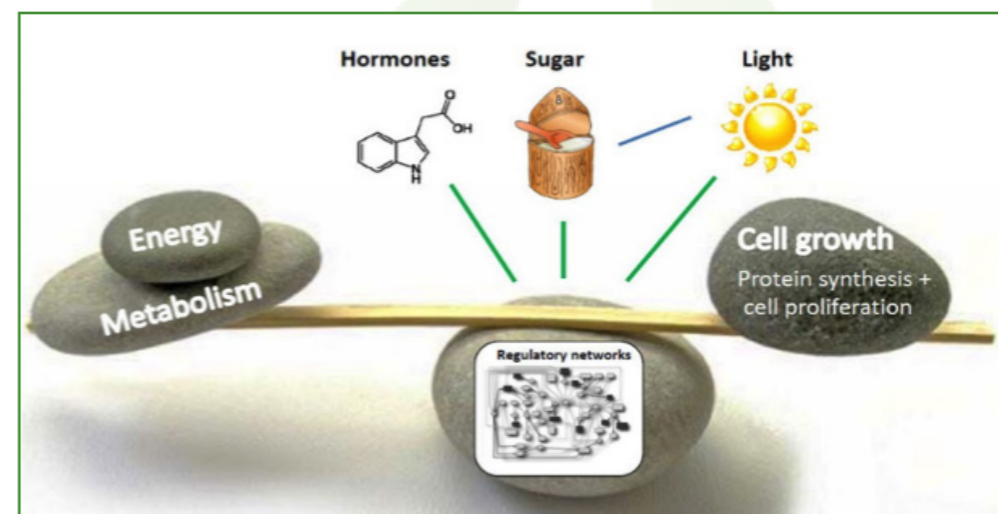

Bogre: The balance between energy, metabolism and growth is influenced by a range of environmental and internal contributors

collaboration with the Pacanaro lab we utilise computational systems biology approaches to study the evolution and connections of signalling pathways and the cell cycle, the evolution of MAPK pathways and their substrate specificities, and use computational methods to model signalling pathway inputs and outputs.

Dr. Paul Devlin.
Paul.Devlin@rhul.ac.uk



Light signalling and applications.
Plant microbiome

One area of fundamental research in my lab is light signalling responses in plants. We are particularly interested in the role of the transcription factors FHY3 and FAR1 in light input to the circadian clock. In *Arabidopsis*, we have shown that FHY3 and FAR1 directly regulate a central clock component in a light-dependent manner. We also have a range of collaborative projects involving fundamental research in *Arabidopsis*: looking at links between the clock and growth with Laszlo Bogre and looking at light regulation of chloroplast development with the group of Enrique López-Juez.

On a more applied level, together with Tony Stead, we are using RNA sequencing in a range of species to examine the applicability of

light treatments to improve beneficial plant traits within the horticulture industry. In collaboration with Vitacress and the RHS, our team is looking at chilling sensitivity in basil and improvement of volatile production in rosemary. Finally, we are also examining factors affecting the plant microbiome. Using a meta-barcoding approach, we are examining the effect of both circadian and environmental

Dr. Alessandra Devoto
Alessandra.Devoto@rhul.ac.uk



How distress signals affect growth in plants.
Biotechnology for health and fuel production

Over 20-years' experience in studying plant (model and crop species) stress responses molecular signalling, and disease-resistance. Expertise includes high-throughput genome-wide functional genomics and bioinformatics, in two main experimental areas integrating fundamental research with applications.

Using a variety of approaches to unravel how distress signals affect growth during defence in plants and the regulatory networks underlying the responses, with the ultimate goal of breeding plants with enhanced tolerance to environmental stress, without compromised growth. We are particularly interested in understanding how plant hormones like jasmonates, mediate these responses, their regulation and cross-talk. Exploiting plant and microorganism genetics to develop sustainable treatments to enhance crop value and nutrients recycling.

We maintain multi- and interdisciplinary, national and international collaborations and have developed important biotechnological platforms integrating bioactivity analyses, with applications for health and energy production and received funding from Research Councils, EU, industry and investors to engineer production of plant (including medicinal) metabolites.

Website: www.Devotolab.org

Prof. Paul, D. Fraser
Dr Genny M.A. Enfissi.
p.fraser@rhul.ac.uk
gennyenfissi@rhul.ac.uk



Biochemistry and Industrial Biotechnology

Plant natural products have been utilised by human civilisation for millennia, providing vital medicines and essential dietary components. The laboratory's main focus has been on the biosynthesis, regulation and manipulation of isoprenoids, particularly plastid-derived isoprenoids, such as carotenoids. These compounds are of high value to multiple industrial sectors, the laboratory has been successful in enhancing nutritionally-related carotenoids such as lycopene, B-carotene and zeaxanthin in tomato and also Capsicum fruits. These sink tissues have also been used as a production chassis for industrial carotenoids, such as ketocarotenoids. More recently we have demonstrated the utility of the platform to deliver superior aquaculture feed additives containing ketocarotenoids, replacing traditional chemically-synthesised products (Nogueira *et al*, 2017, PNAS 114, 10876; www.disco-fp7.eu).

Experimentally the laboratory routinely uses metabolomics and proteomics as a means to study the effects of perturbations across metabolism and characterise both the plastid and sub-plastid

organellar structures. Our metabolomics platforms have also been utilised in BMGF and CGIAR projects to augment plant breeding programmes for improved quality traits in staple Root Tuber and Banana crops. The non-conventional industrial yeast *Xanthophyllomyces* (formally *Phaffia*) has been developed as a production platform for valuable terpenoids. This involves the creation of mutants via chemical mutagenesis and the development of Synthetic Biology tools for optimal terpenoid production (ERA-IB-PROCAR project).

Prof Alan Gange.
a.gange@rhul.ac.uk



Plant microbiome, multitrophic interactions

Much recent work has focused on characterization of the microbiome, but what are the roles of root and shoot microbiomes in plants, and how can we manipulate these to provide enhanced resistance to pests and diseases?

My lab is investigating the effects of microbiome manipulation on the growth and reproduction of herbivorous insects, with the aim of developing sustainable methods of biological pest control. In the soil, we study the effects of arbuscular mycorrhizal fungi and plant growth-promoting rhizobacteria on the performance of root- and shoot-feeding insects. We have found



Fraser and Enfissi: Figure demonstrating phenotypes and profiles of *N. glauca* expressing the ketocarotenoid biosynthetic pathway genes (Mortimer *et al* DOI: 10.1104

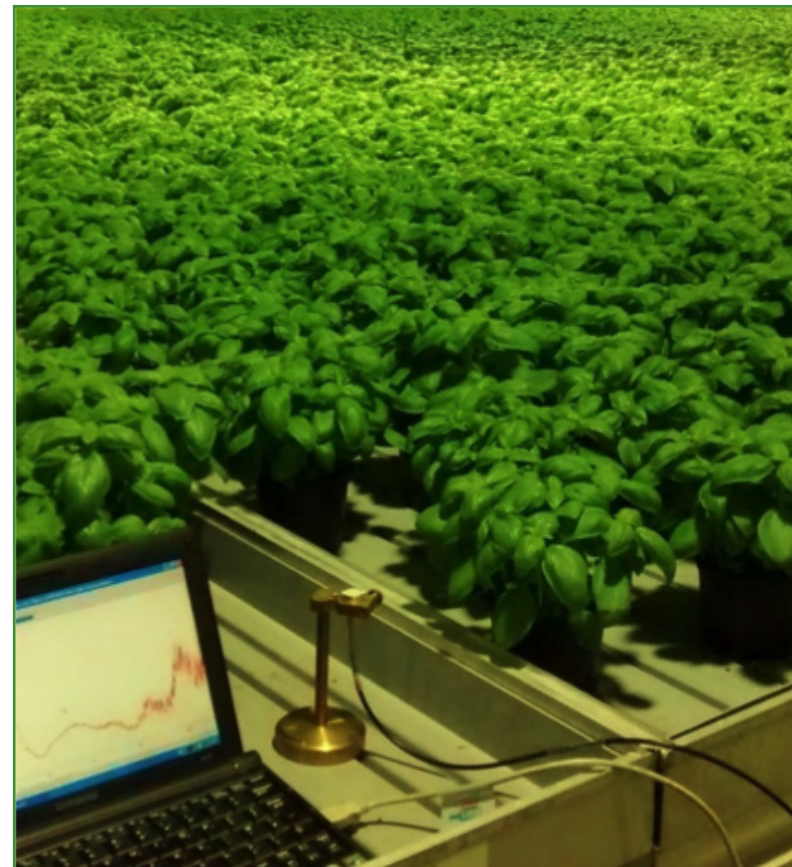

Devlin: Control of the light environment for basil production

factors and, in collaboration with Alan Gange, we are investigating the effects of microbial supplementation on beneficial plant traits.

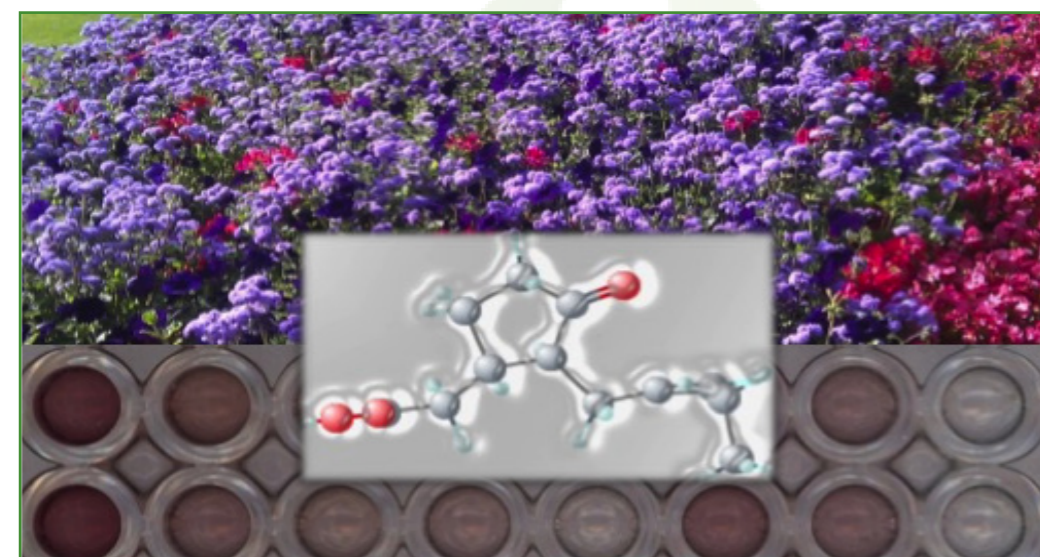

Devoto: Bioactivity analyses and scale-up activities encompassing plant biochemistry and animal cell biology



Gange: Golf greens are challenging plant communities to work with, plants are only about 4mm tall!

Prof. Julia Koricheva.
julia.koricheva@rhul.ac.uk

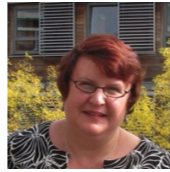

Plant-herbivore interactions. Meta-analysis and research synthesis

Research in our lab focuses on interactions between plants and herbivores. Specifically, we are interested in mechanisms behind the phenomenon of associational resistance which occurs when a plant is protected from herbivores when it grows in associations with other plant species or genotypes. Most of the research on our group is done in forests, particularly in the long-term forest diversity experiments in

SW Finland (www.sataforestdiversity.org) where both tree species diversity and tree intraspecific genetic diversity are manipulated by planting monocultures and mixtures of different tree species and different silver birch genotypes.

We demonstrated that associational resistance in mixed stands is frequently linked to changes in canopy cover around a focal tree. For instance, associational resistance of Norway spruce to a galling adelgid is driven by increased

that the identity of the species of fungi and bacteria is very important in determining the outcome of any interactions with insects. This has important implications for the development of microbial inoculants, which are becoming popular and are often marketed as 'biostimulants'.

Above ground, we focus on endophyte fungi in herbaceous plants. These were once thought to be opportunists, having loose relations with their hosts. We have found that they can have profound effects on insects and that one group, the entomopathogenic fungi, have huge potential as bioprotectants in agricultural crops.

Our research involves a diverse array of crops, including sports turf, soft and top fruit, herbs and Brassicas. Meanwhile, our more ecological work involves the biological control of weeds, particularly Himalayan balsam, where we work with CABI, testing a consortium of fungi for its control.

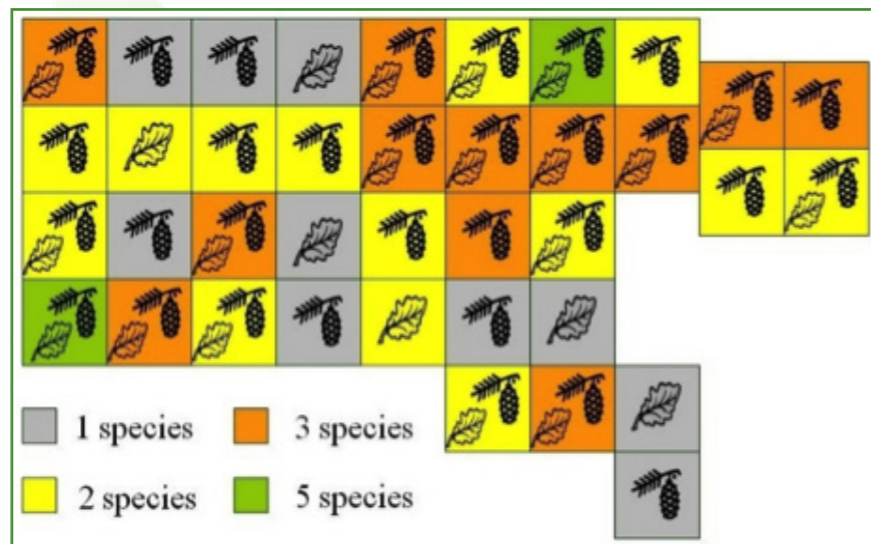

Koricheva: Design of the Satakunta forest diversity experiment

shading by taller heterospecific neighbours in mixed stands.

For silver birch, lower canopy cover in mixed stands resulted in reduced foliar quality and, thus, associational resistance. We are also using methods of meta-analysis to combine the results from published studies. Our recent meta-analysis on the effects of plant intraspecific diversity on arthropods showed that species richness and abundance of most trophic groups of arthropods were higher in genetically diverse plant stands and the magnitude of plant genetic diversity effects was comparable to that of vplant species diversity.

Prof. Gerhard Leubner.
gerhard.leubner@rhul.ac.uk



Seed Biology and Engineering

About thirty years since the emergence of *Arabidopsis thaliana* as plant model, it is clear that the focus to integrate plant

science with genetics and molecular biology has broadened from a single organism. In the Group for Seed Biology and Engineering (www.seedbiology.eu) at Royal Holloway, University of London, we focus on applied and fundamental aspects of seed research – from crop seed quality and technology research enhancing seedling performance, to climate change and seed adaptations to abiotic stresses.

This includes use of new model species for comparative analyses. One such example is *Aethionema arabicum*, a small, diploid, annual species belonging to the earliest-diverging, sister group within the *Brassicaceae*. The species is dimorphic, forming two distinct fruit and seed morphs differing in morphology, dispersal, and germination behaviour.

Together with the ERA-CAPS SeedAdapt project led by RHUL (www.seedadapt.eu), we are using this species as model system for seed and fruit dimorphism to elucidate the molecular mechanisms of early-life history traits that have evolved as a bet-hedging strategy in variable and

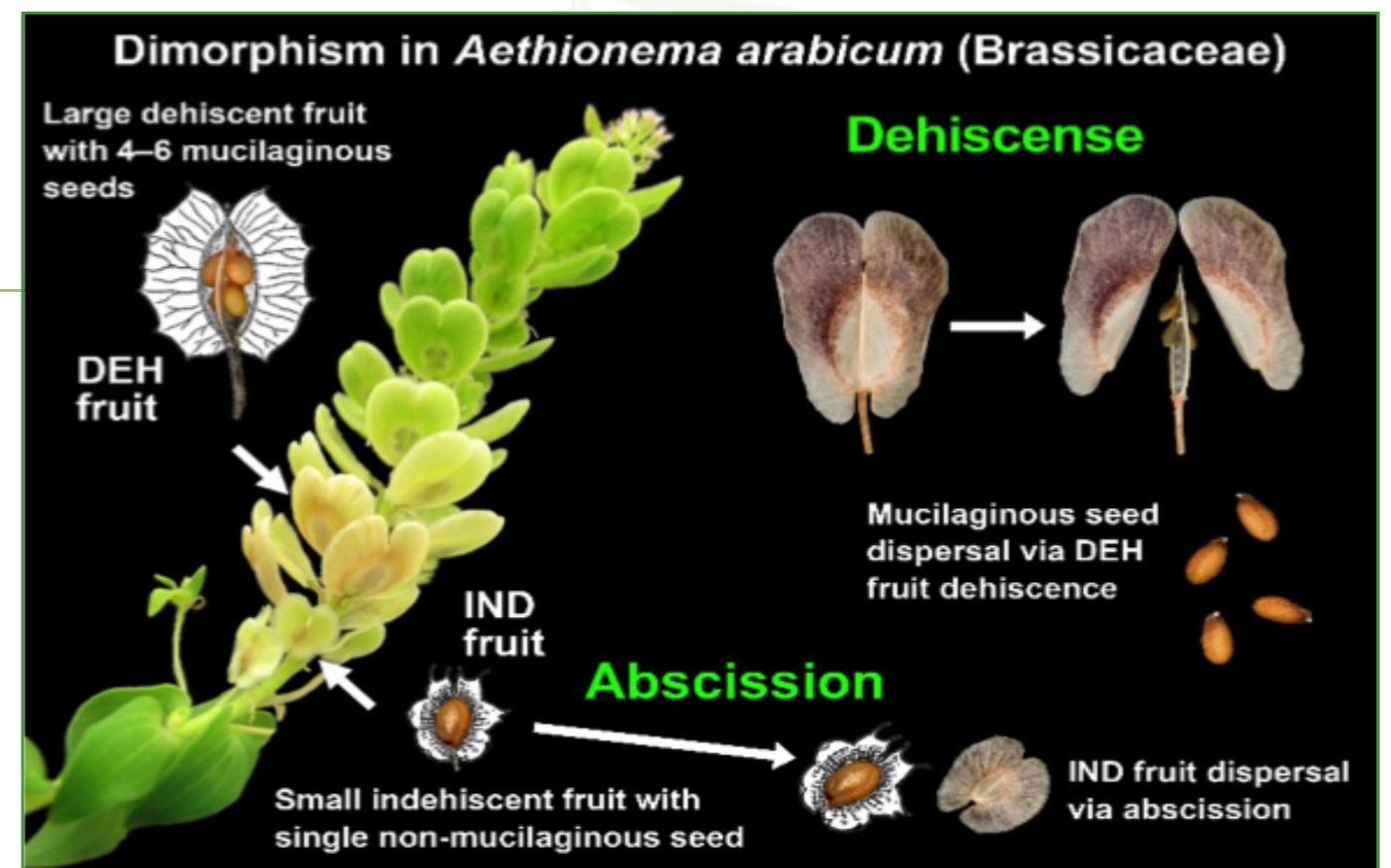

unpredictable environments. The availability of the *Ae. arabicum* genome facilitates our comparative investigation of abiotic stress-related epigenomes, hormonomes, and transcriptomes, thereby making it an exciting time to study remarkable plant diversity by moving beyond *Arabidopsis*.

Dr. Enrique López-Juez.
e.lopez@rhul.ac.uk



Chloroplasts and leaf development

Arguably plants are self-built, self-maintained solar panels that we depend on. Work in many laboratories has led to tremendous insight into the mechanisms through which leaf organs, the “panels”, are built at shoot meristems, and chloroplasts, the “solar cells”, differentiate, yet that insight is limited: it is far from allowing us to build larger organs, or to instruct cells to develop chloroplasts when, where and to the extent that we wish.

Our laboratory is addressing some of these fundamental, long-term questions. Photobiology provides us with a natural, off/on switch to address endogenous regulatory mechanisms. *Arabidopsis* gives us three invaluable resources: genetics, including classic mutant isolation, reporter-based and suppressor screens, and reverse genetics, state-of-the-art monitoring of cellular activities, including reporter genes and global expression analysis, and interaction with a very dynamic like-minded community, within and beyond Royal Holloway. We have developed effective methods to monitor gene expression with spatial resolution, and to address in fine quantitative detail organelle development (using quantitative microscopy and gDNA and rRNA-based techniques). This has recently provided us also with a platform to address similar questions during the development of cereal leaves.

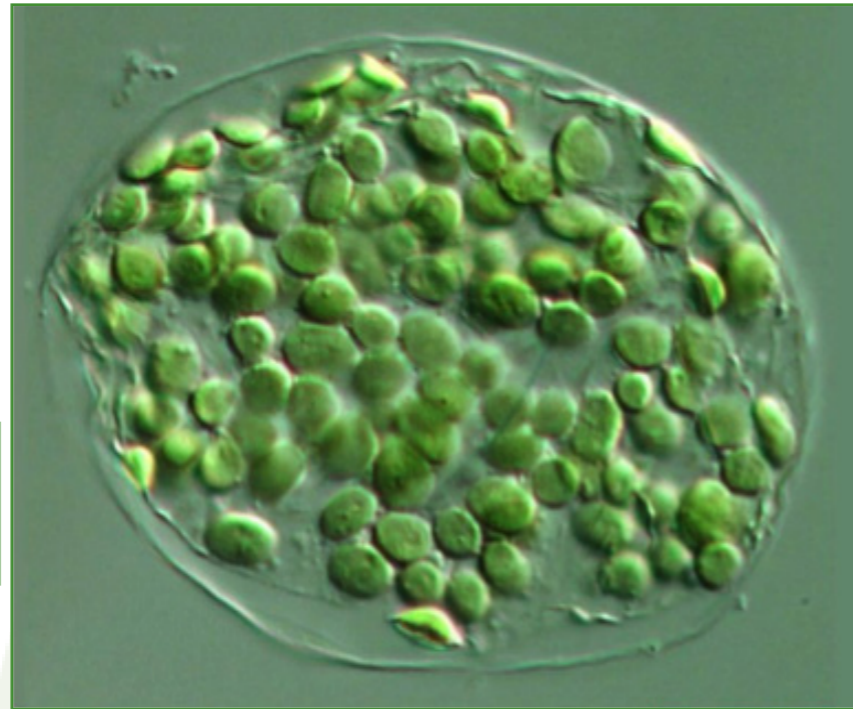

Lopez-Juez: A chloroplast-filled isolated mesophyll *Arabidopsis* cell

Dr Tony Stead
a.stead@rhul.ac.uk



Horticultural and Ornamental Physiology

The fast growing genomic resources on *Arabidopsis* and other species are proving useful to identify genes and pathways associated with practical issues associated with horticultural produce. Adjustments in the light regime within the greenhouse (work with Vitacress) has provided a considerable degree of chill tolerance in basil and can permit basil, along with other herbs, to be transported at lower temperatures thereby prolonging their shelf life. Similarly the issue of leaf breakdown, caused by low temperature and/or low light levels is being investigated through RNAseq and microscopy.

Dahlias may be a popular garden plant but they are rarely seen in the supermarkets as cut flowers. Treatments with commercial floral preservatives provide little or no extension of vase-life but applications of cytokinins have been found to be beneficial. The expression of genes associated with flower senescence and



Stead: Special formulations of flower food are available for lilies and Alstroemeria (left) but these are formulated to delay leaf yellowing which can occur in untreated flowers making stems unattractive even before the flowers die (right).

cytokinin treatment has been identified (work with Greenyard Flowers and Waitrose). Whilst in roses bent-neck, or necking, is a common cause of premature stem failure, often this is said to be caused by vascular blockage by bacteria but this appears to be only part of the story, other factors such as plant age, variety, etc. contribute to the problem and, using RNAseq, critical pathways have been identified that seem to be associated with this phenomenon (work with Flamingo Holdings).



<https://www.studenthut.com/universities/royal-holloway-university-london-profile>

GARNet Gene Editing Workshop

University of Bristol

March 26-27th 2018

Ashley Pridgeon

ashley.pridgeon@bristol.ac.uk

Beth Eldridge

bethanyeldridge@bristol.ac.uk

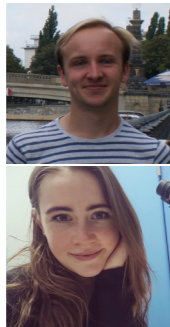

Over the 26-27th March, researchers from around the globe gathered at the University of Bristol for the GARNet Plant Gene Editing workshop. At this workshop, attendees eagerly discussed topics relating to gene editing; these discussions not only encompassed the nitty-gritty details of how to edit stubborn plants (monocots and dicots alike!), but also novel uses of genetically-modified plants and the policies concerning their regulation. Alongside these discussions, researchers got the opportunity to view an array of scientific posters that sparked fruitful conversations.

Following the morning meet-and-greet, the workshop began with a keynote plenary from Stefan Jansson, creator of the first GM meal, who described his experiences of conjuring up culinary delights using genetically modified kale, or as

Stefan put it “CRISPRy kale”. Stefan also reminded us how the gene-editing approaches we use today make it near impossible for authorities to prove whether an organism has been genetically modified using these technologies since Stefan easily moved around different European countries with his CRISPRy kale (to cook up a culinary storm for intrigued journalists) without being quizzed by border control...

The rest of the day encompassed all things technical – i.e. how to gene edit both dicot and monocot plants using the latest gene editing technologies. All the talks and discussions were engaging and sparked much debate regarding how to or how to not successfully edit plant genomes. Some highlights from these talks include Michaela McGinn, who championed Pennycress, a Brassicaceae family member with an 86% sequence similarity with Arabidopsis, as a new industrially relevant model organism which shows compatibility with CRISPR gene editing techniques. Using the American Midwest as an example, Michaela explained how Pennycress with its high seed oil and protein content could be cultivated in winter, between the corn and soybean growing seasons, to produce food or biofuels without taking up extra farmland. Michaela also described her experiences in optimising Pennycress transformation and gene editing procedures as well as the relative ease as to which the vast body of Arabidopsis research can be translated to this potentially exciting crop plant.

Andreas Weber gave us a fascinating insight into the current efforts to introduce efficient C4-photosynthesis into less-efficient C3 plants. Moving away from CRISPR, Heather Whitney gave us a captivating insight into her groups novel work on carbon nanodots (freshly made from a Tesco’s microwave) and their potential to deliver DNA to recalcitrant plants. The day ended with



Networking during the poster session Photo Helen Harper

a keynote plenary from Ben Davies, the Head of Transgenic Research at the Wellcome Trust Centre at the University of Oxford, who discussed the use of CRISPR to modify mice genomes and most importantly highlighted parallels between the struggles of trying to edit mammalian and plant genomes, as Ben put it “we are all in this together”.

The second day started with the policy section of the workshop titled “Gene Editing and Global Regulatory Landscape”. Highlights from this section include the talks by Dennis Erickson and Gary Marchant, who both gave great overviews of how policies regarding gene editing and modified crops are made in Europe and the United States respectively. Both of these talks highlighted the (in some cases bizarre) complexities behind the policy making processes and emphasized the importance of the imminent European Court of Justice (ECJ) decision regarding Gene Editing technology. It is clear that there is general confusion when it comes to regulating genetically modified plants, which is most evident when we consider that even arriving at a definition of what a genetically modified organism (GMO) is has been difficult. It is especially telling that until very recently legislation in the USA treated as GMO crops as plant pests. Gary’s talk focused on promoting a risk based regulatory approach

to genetically modified crops, an approach that concentrates not on the trivial risks that dominate the public sphere, but the serious risks that can cause potential problems. In the USA, current legislation is also having a negative economic impact. The costs required to get gene edited crops approved through the regulatory system prevent all but the largest corporations from getting products onto the market. Gary highlighted there is need for a consensus on the definition and regulations regarding GMOs, not just on a national level but international as well. Without consensus, we risk trade conflicts between international trading partners such as the USA and EU.

The conference finished with talks regarding novel uses of gene editing technology. Highlights include Fabien Nogue who discussed his groups work on polymerase and homology directed repair, showing how work in the model moss *Physcomitrella* can direct research in higher plants. Alexander Leydon talked about the development of synthetic hormone activated Cas9 repressors. Alex described the modular nature of these molecular tools and how they have been used to study and control the gibberellic acid signalling systems.

From the perspective of two early career researchers who are fairly new to the world of gene editing, this two-day conference provided us with a thorough introduction to the field. We were surprised to find that one of the biggest challenges researchers face when trying to successfully edit plant genomes does not surround the design of the editing cassette itself, but the methods used to deliver a functional editing cassette into the plant.

All in all, it was a productive and intriguing two days filled with great science and people.



The Conference Dinner. Photo Helen Harper

GARNet2018: a plant science showcase

University of York
September 18-19th 2018

Five Plenary Sessions:

- > *Large Scale Biology*
 - > *Innovations in Hormone Signaling*
 - > *Interacting with the environment*
 - > *Out of Arabidopsis*
 - > *Novel Cell Imaging*
-
- > *Keynote: Prof Dame Ottoline Leyser*
 - > *10 talks from abstracts*
 - > *15 Flash presentations*

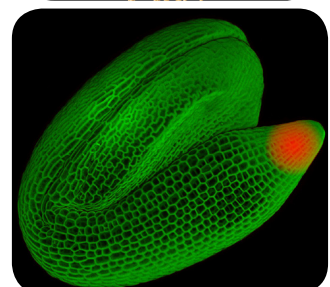
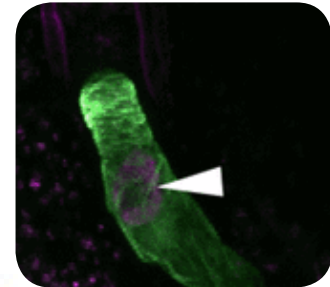
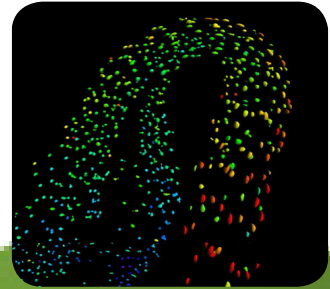

<http://garnet2018.weebly.com/>